

Organization Chart

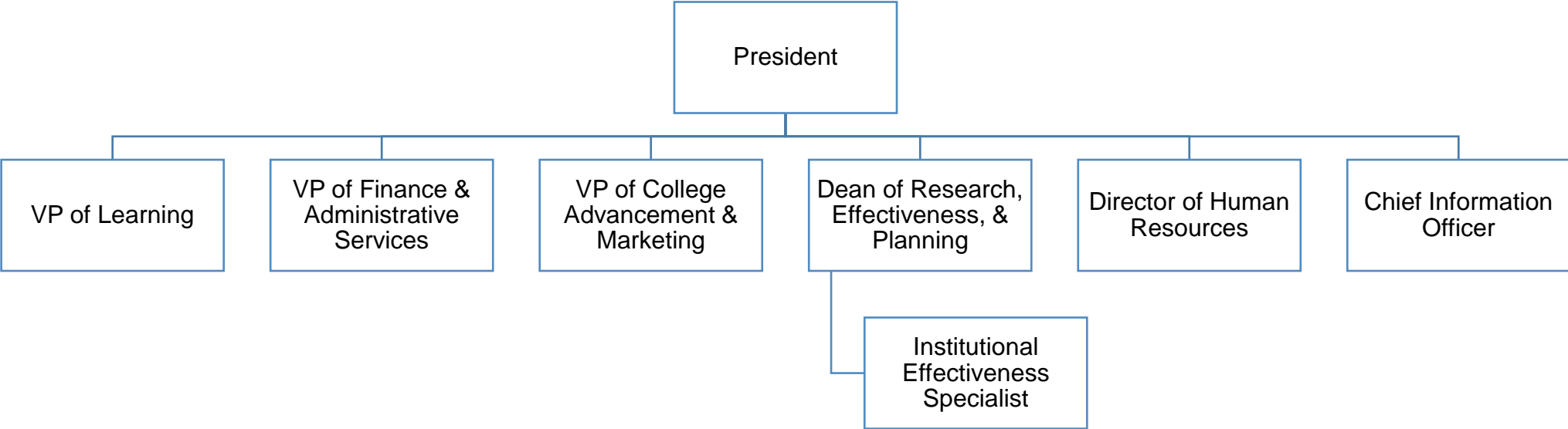

President

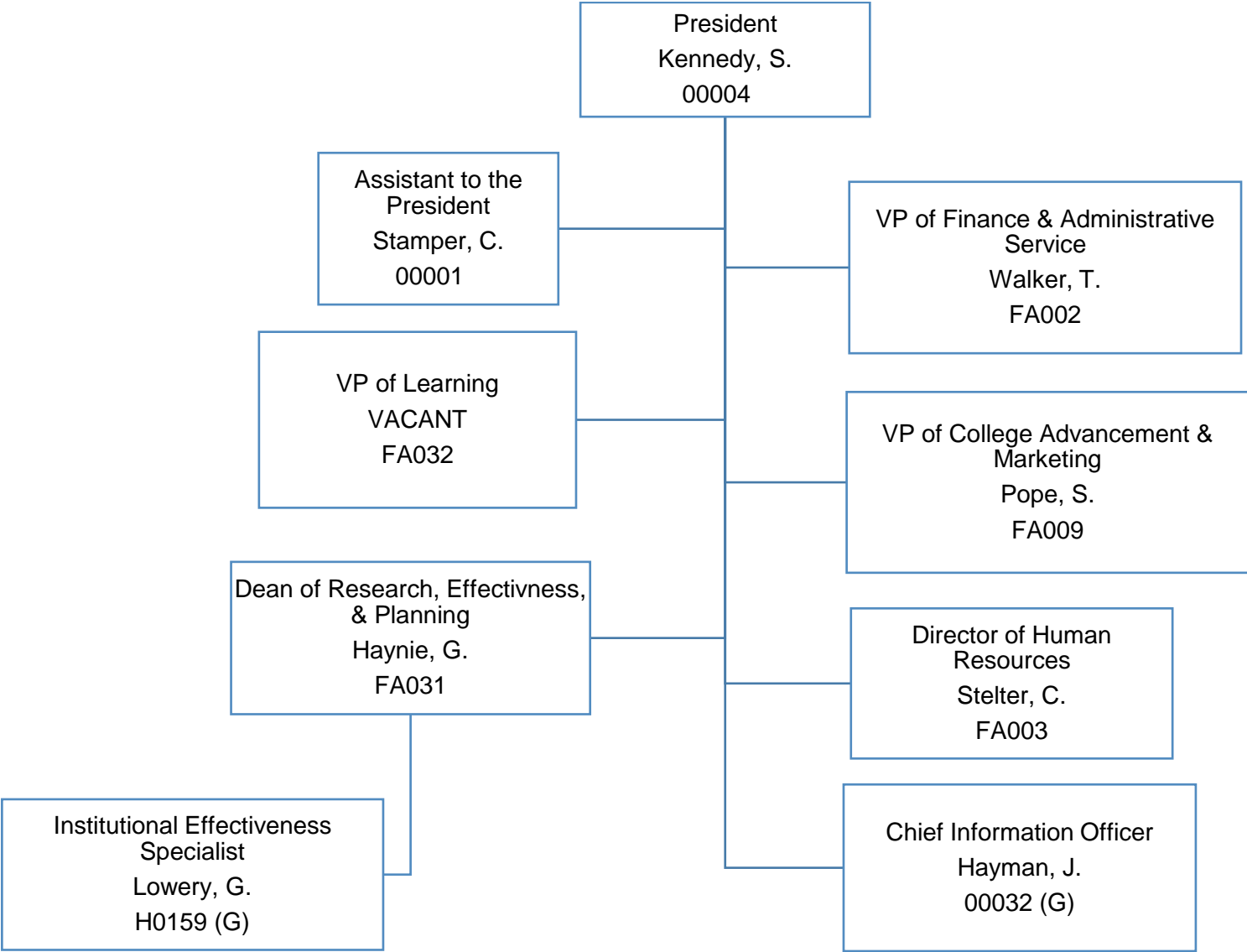

VP of Learning

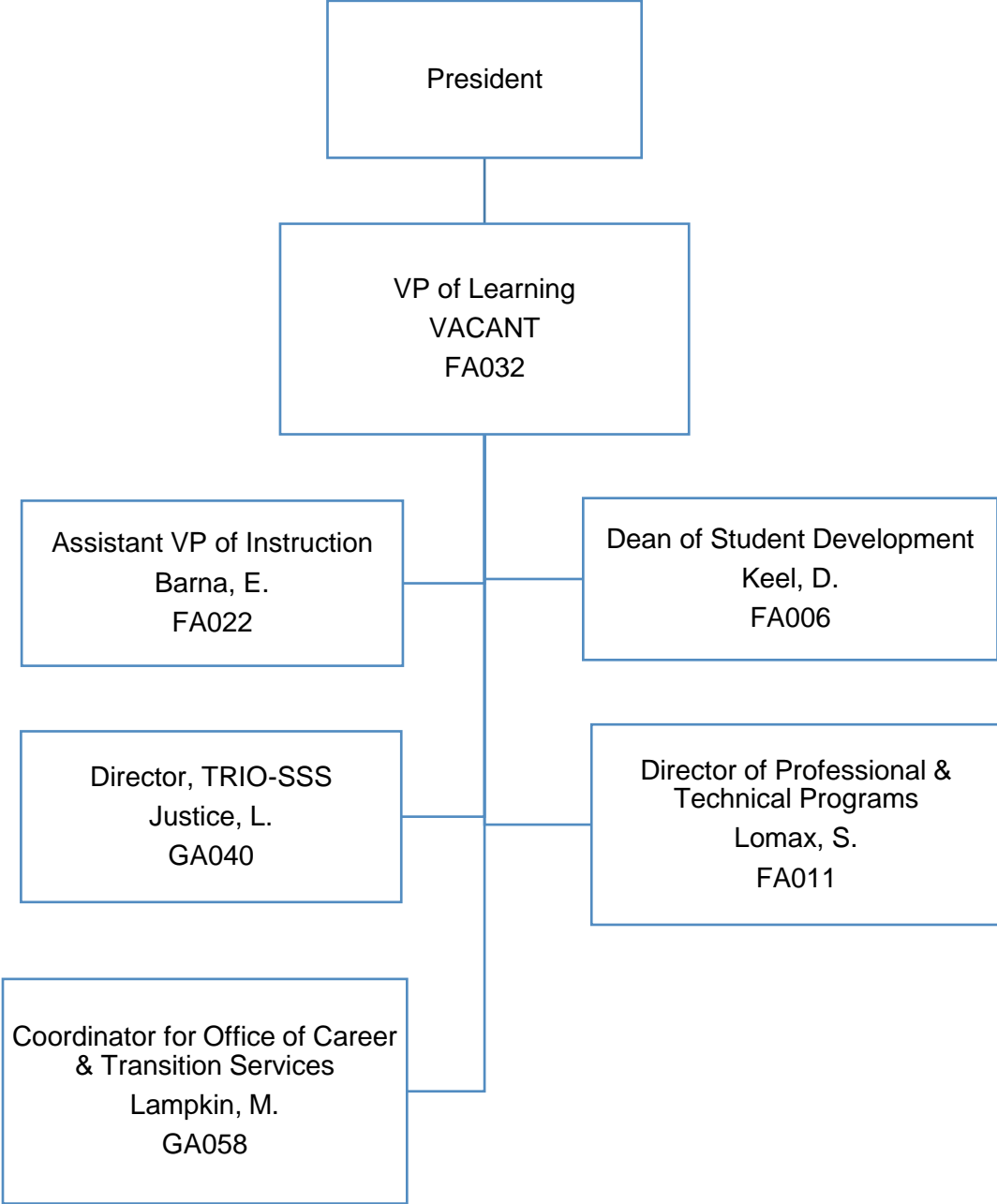

VP of Learning; Assistant VP of Instruction

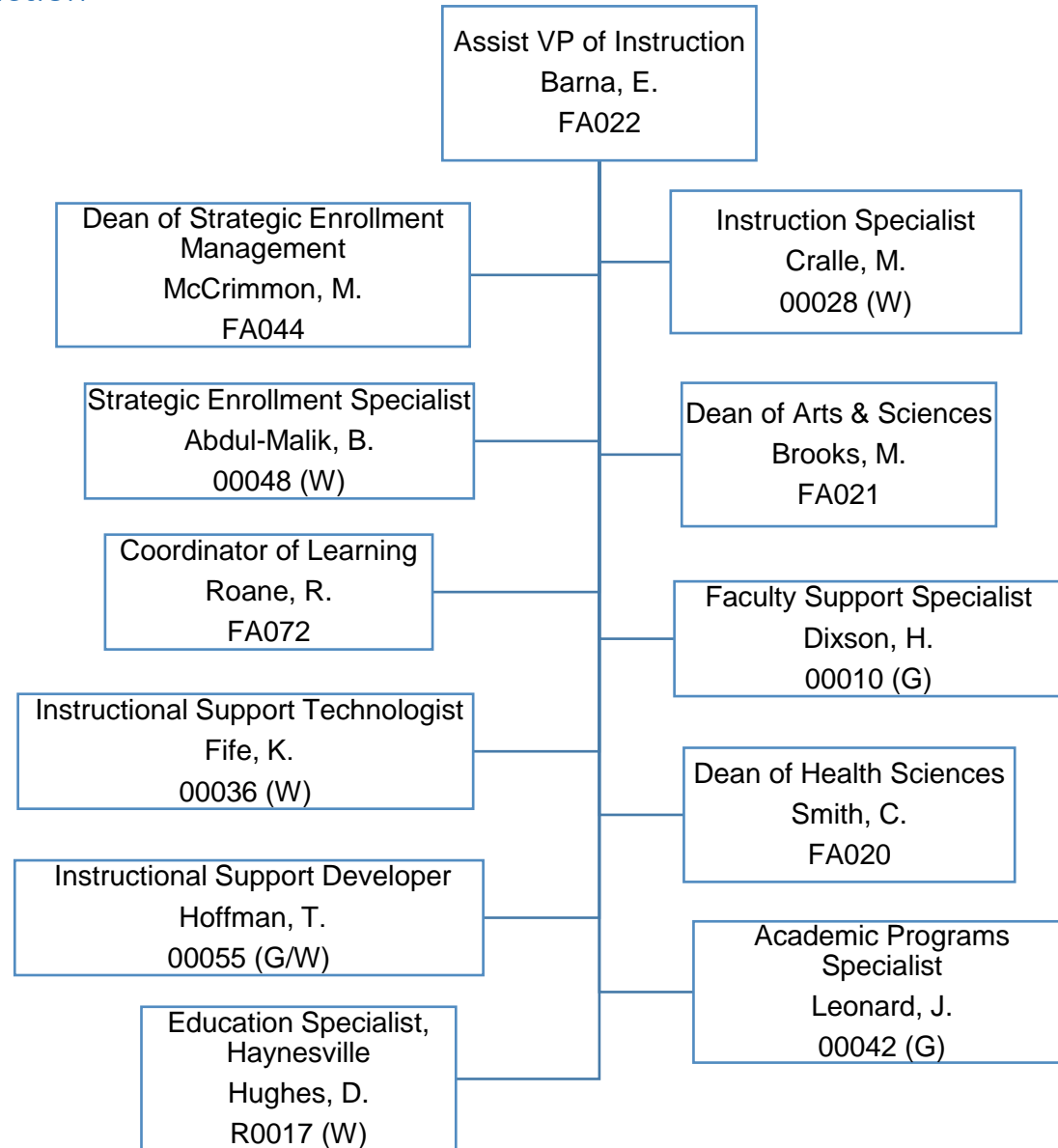

Assistant VP of Instruction; Dean of Arts and Sciences

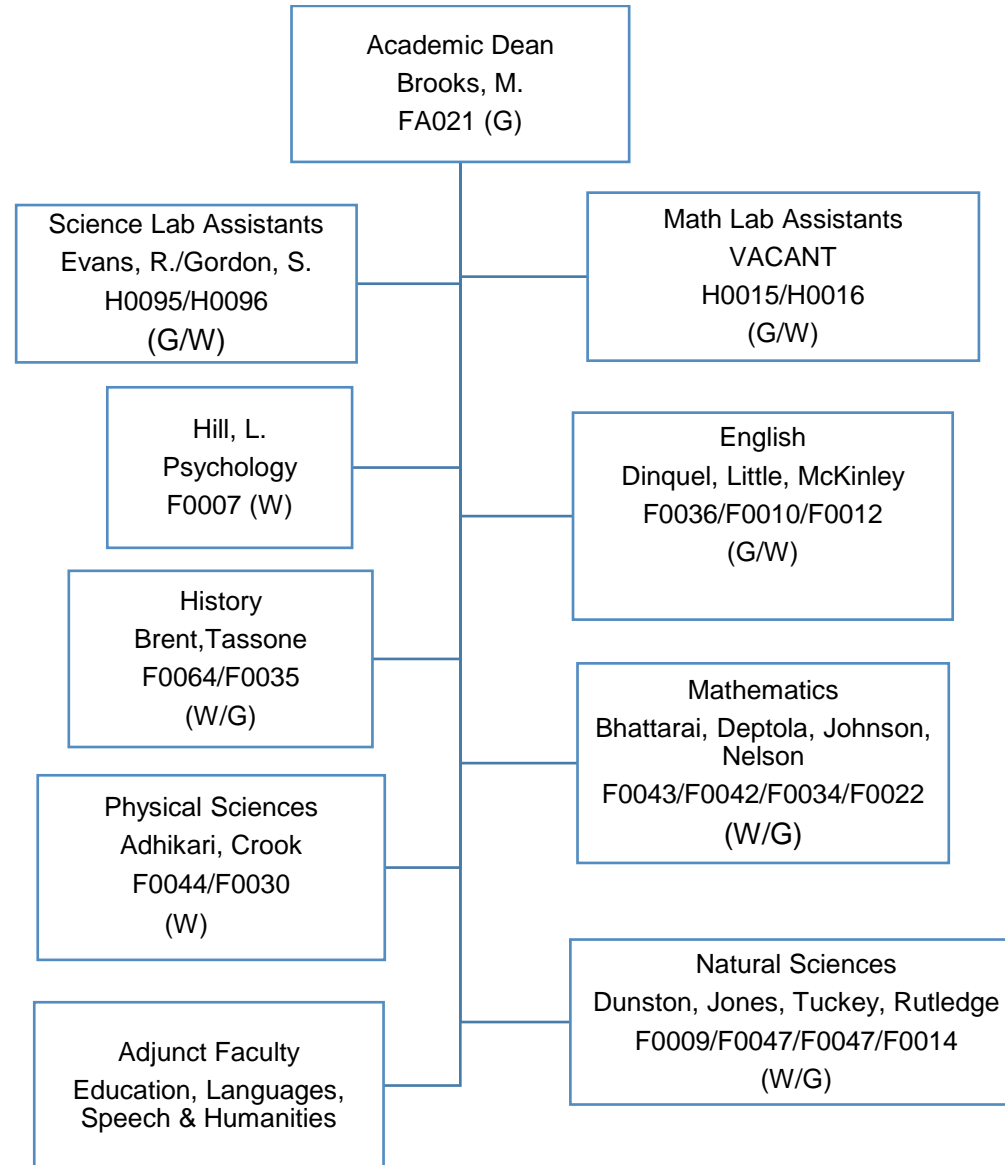

Assistant VP of Instruction; Dean of Health Sciences

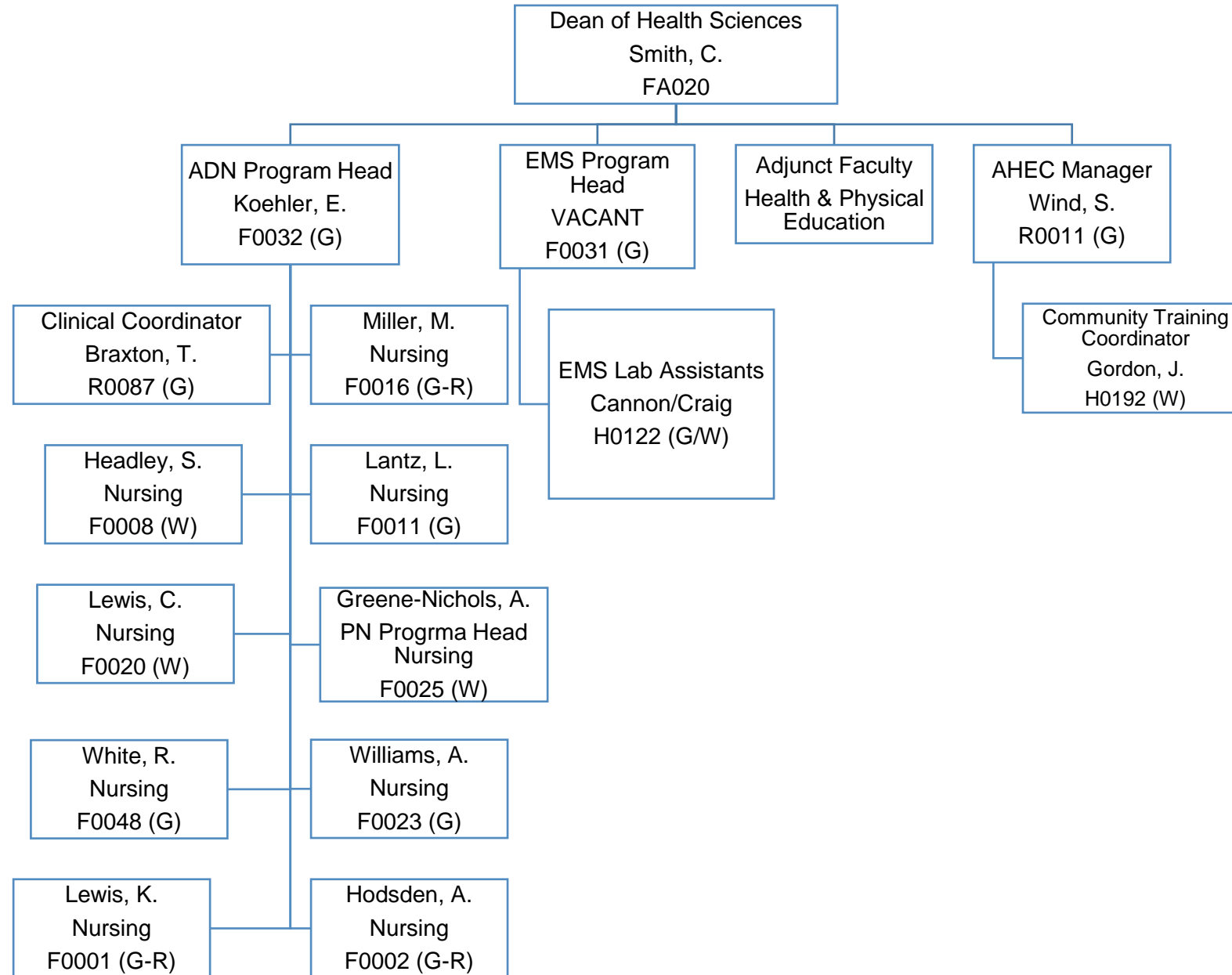

Assistant VP of Instruction; Dean of Strategic Enrollment Management

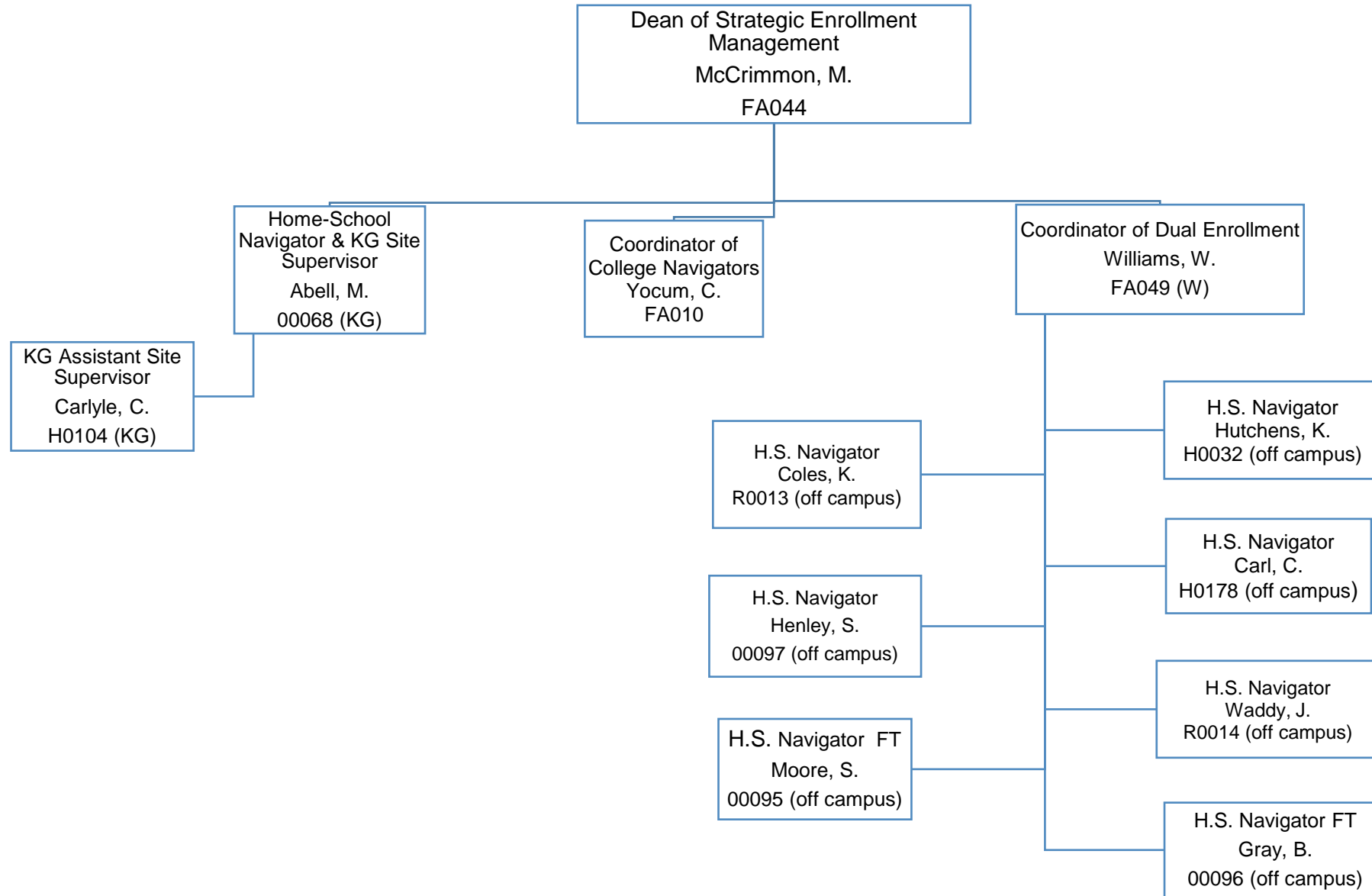

Dean of Strategic Enrollment Management; Advising Team

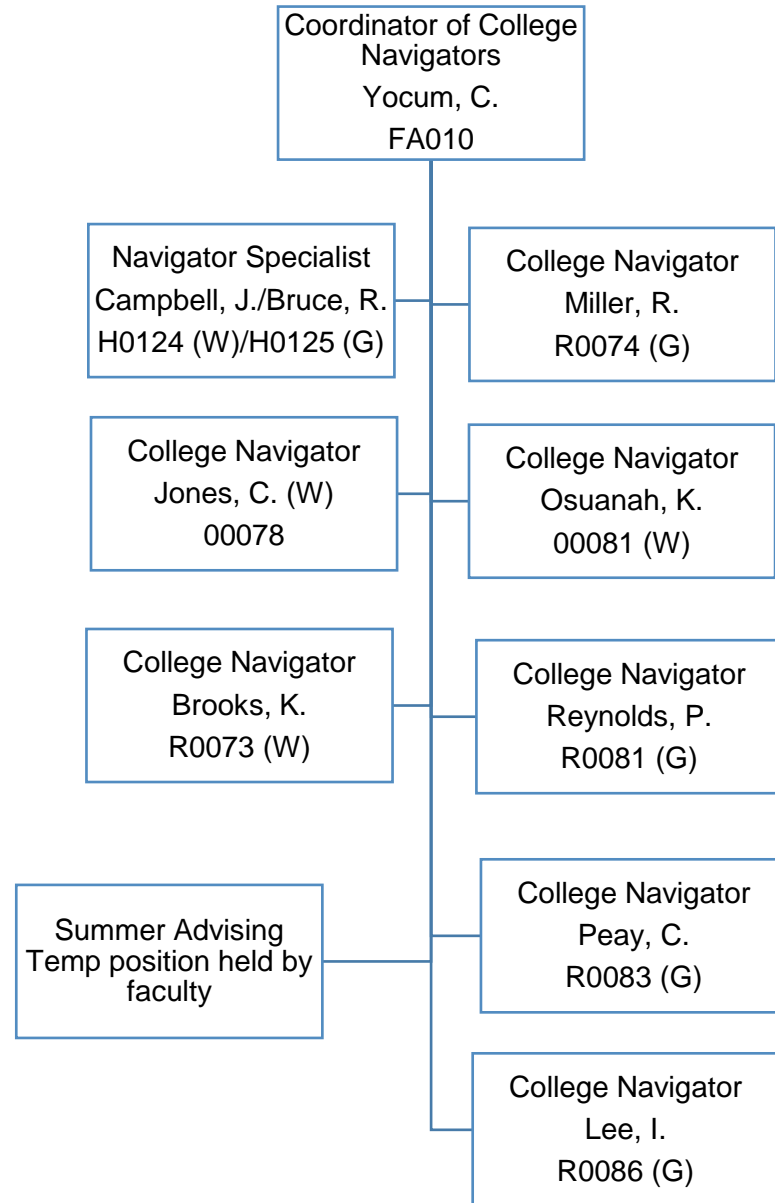



Assistant VP of Instruction; Coordinator of Library Resources

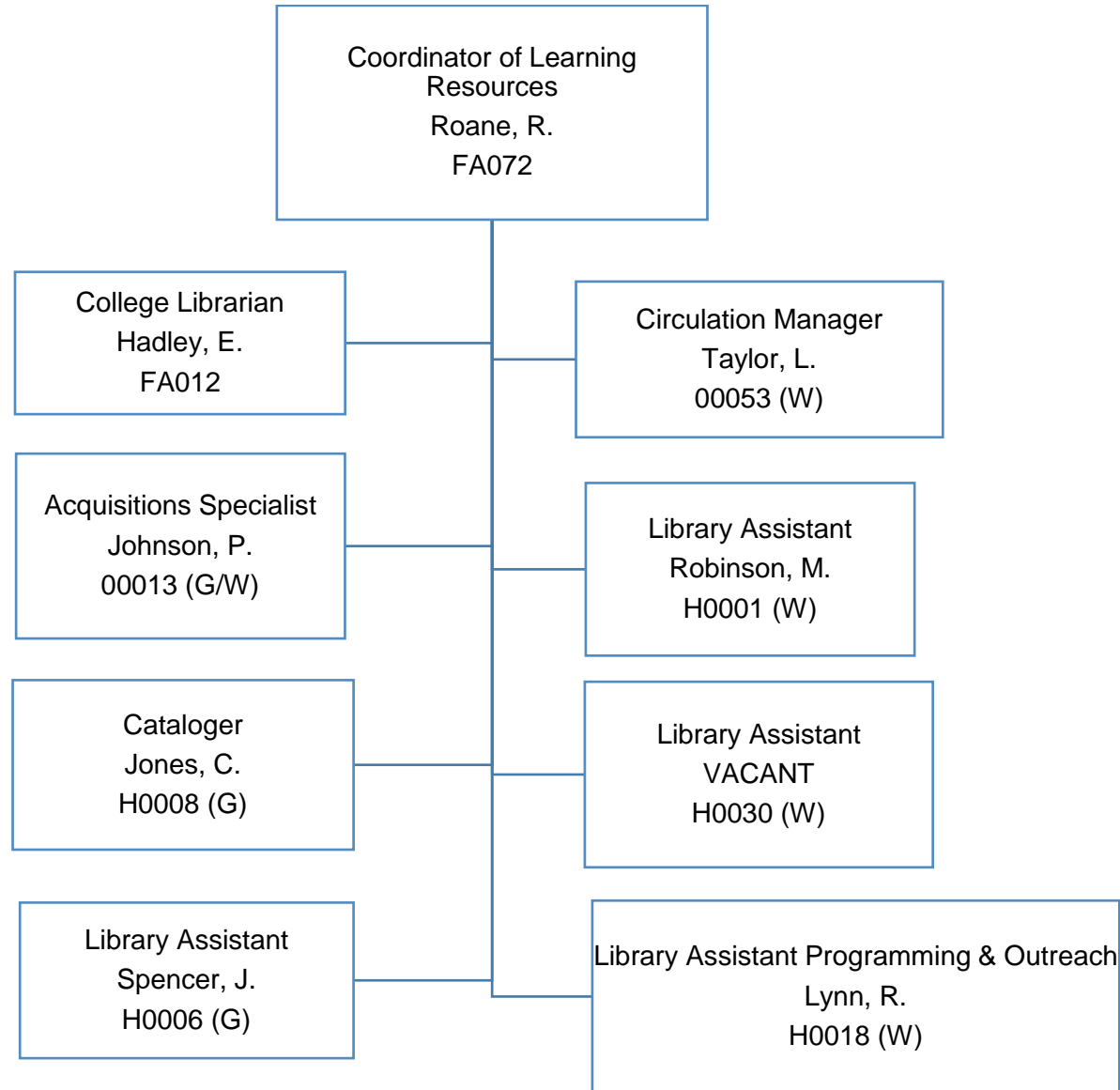

VP of Learning; Director of Professional & Technical Programs

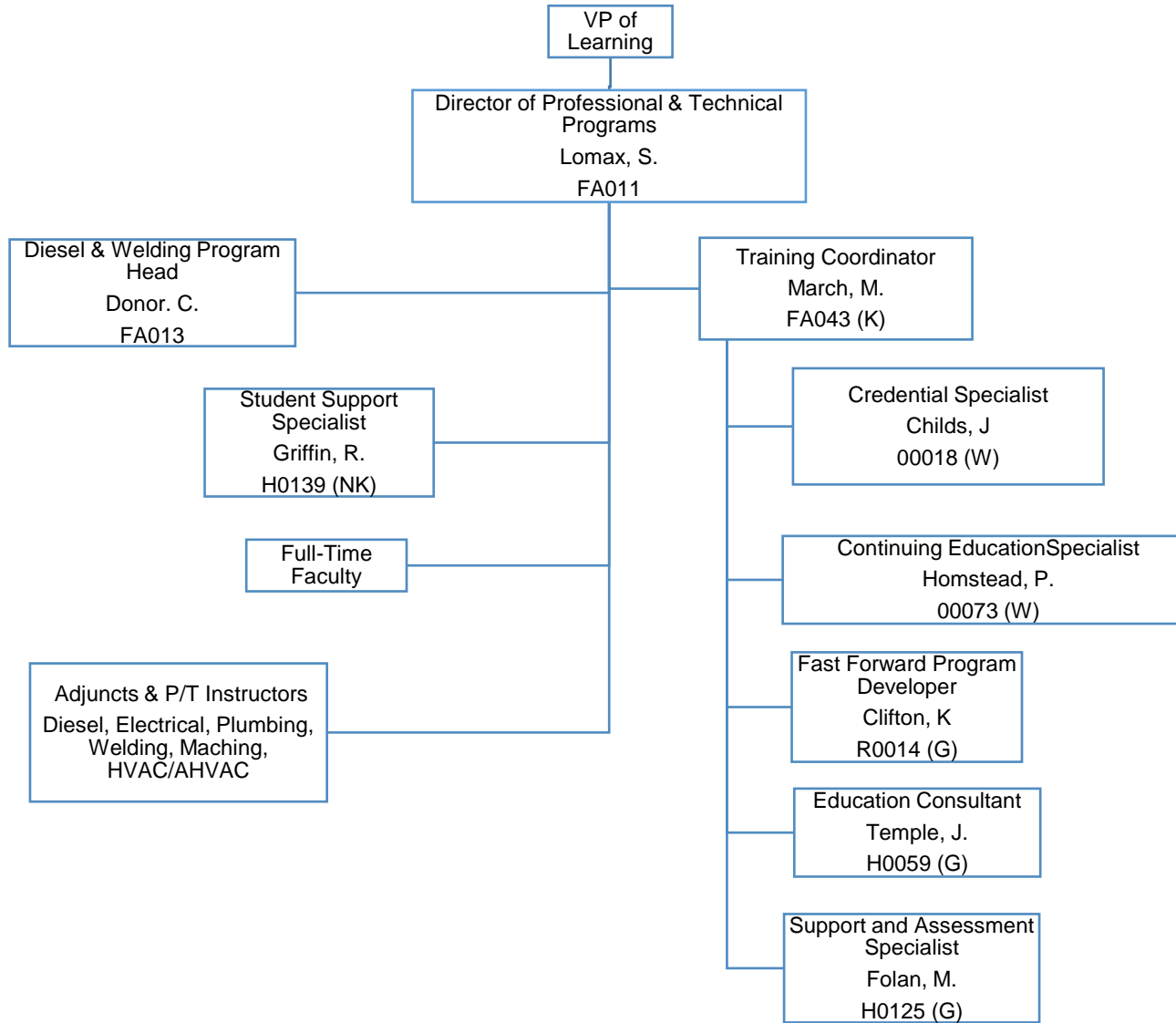

Director of Professional & Technical Programs; F/T Faculty

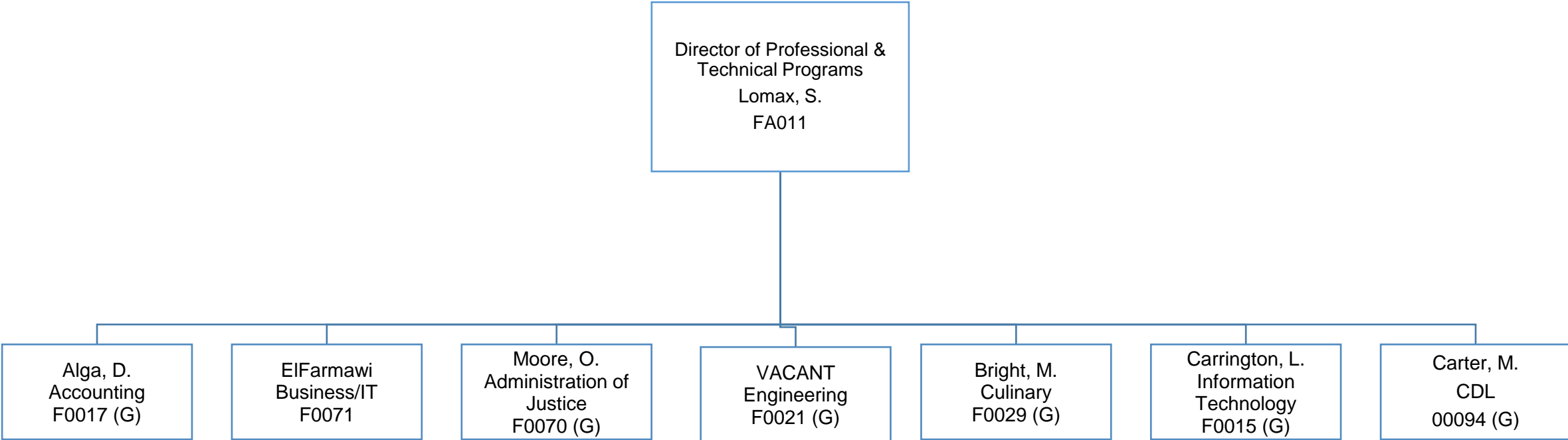

VP of Learning; Student Support Services

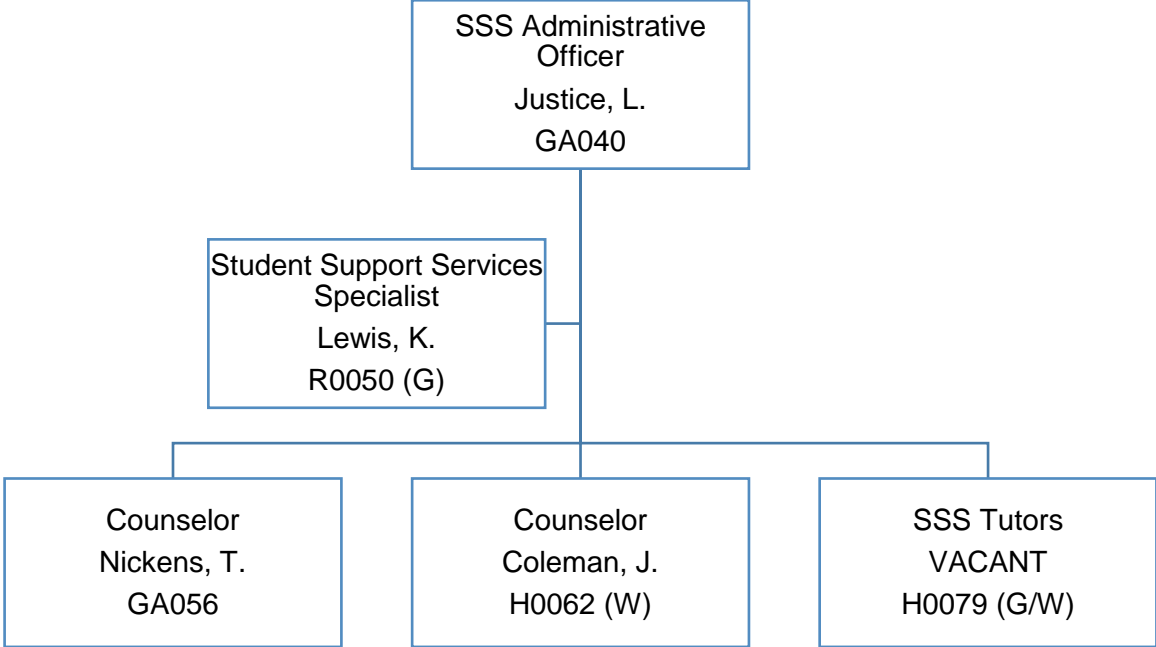

V.P. of Learning; Dean of Student Development

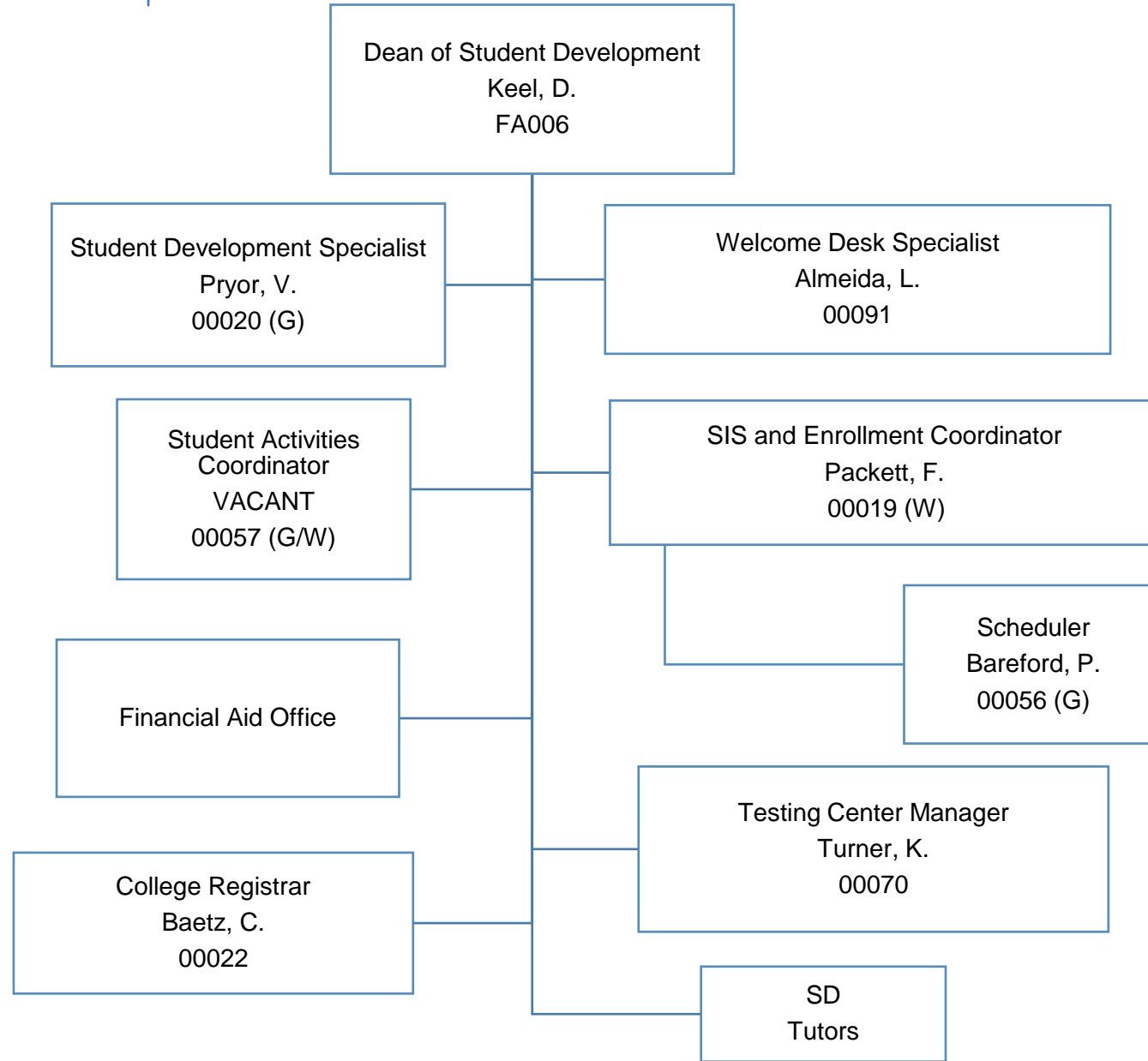

Dean of Student Development; Financial Aid

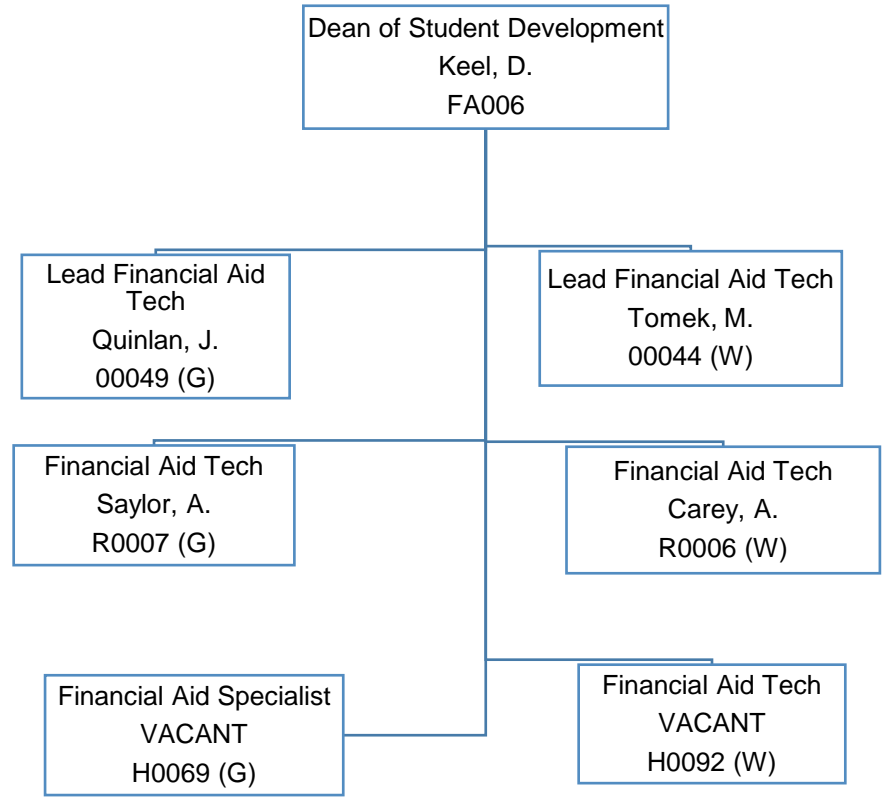

Dean of Student Development; Testing Center

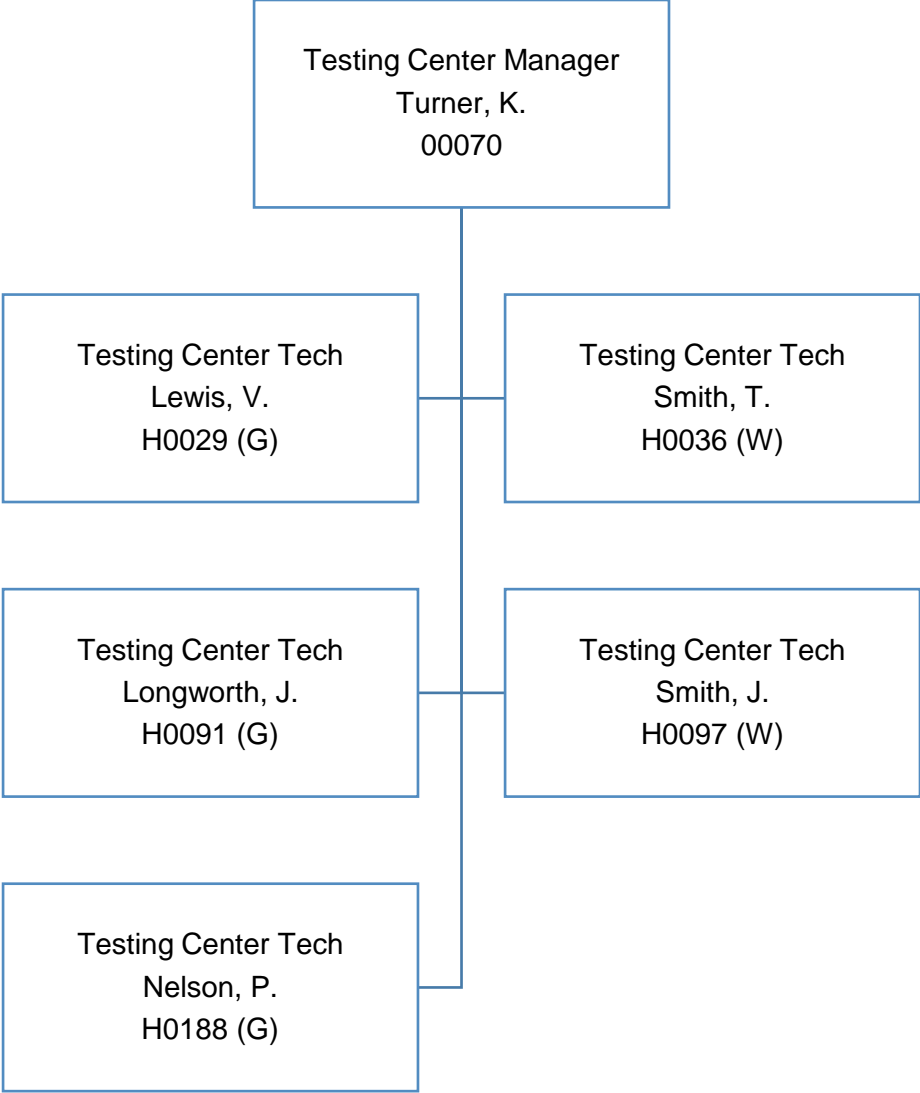

Dean of Student Development; Admissions and Records

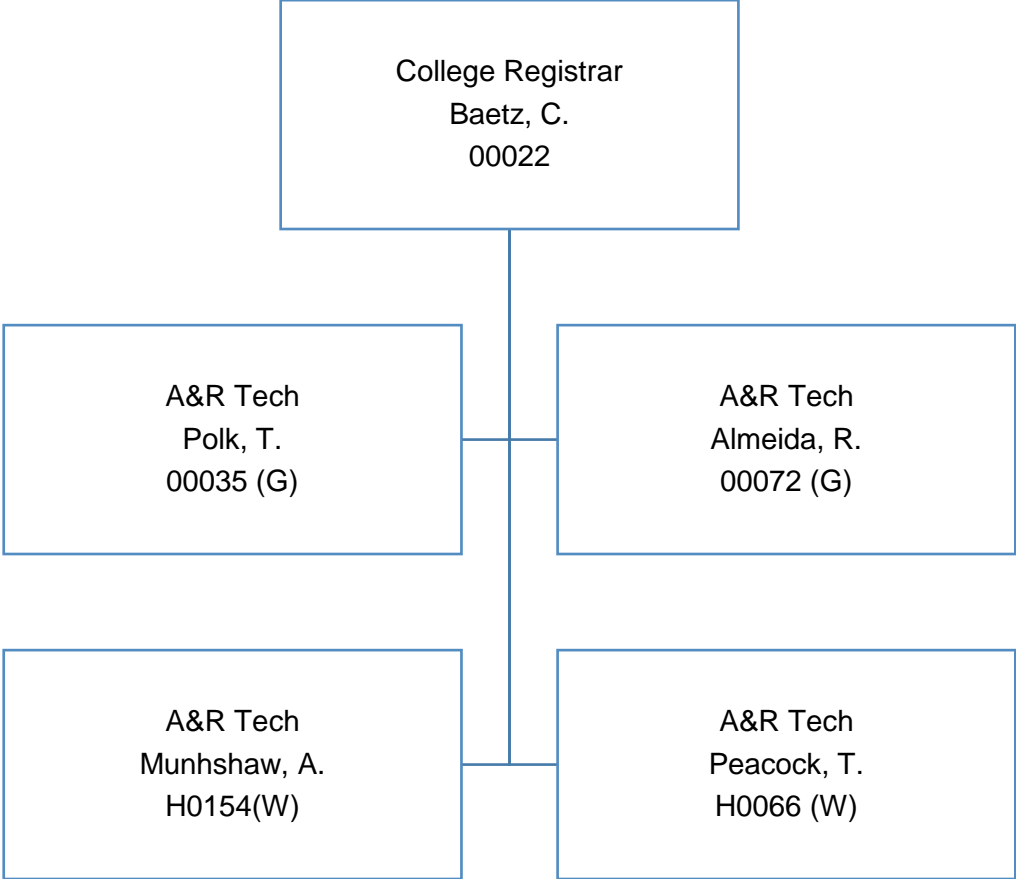



VP of Learning; Office of Career & Transition Services

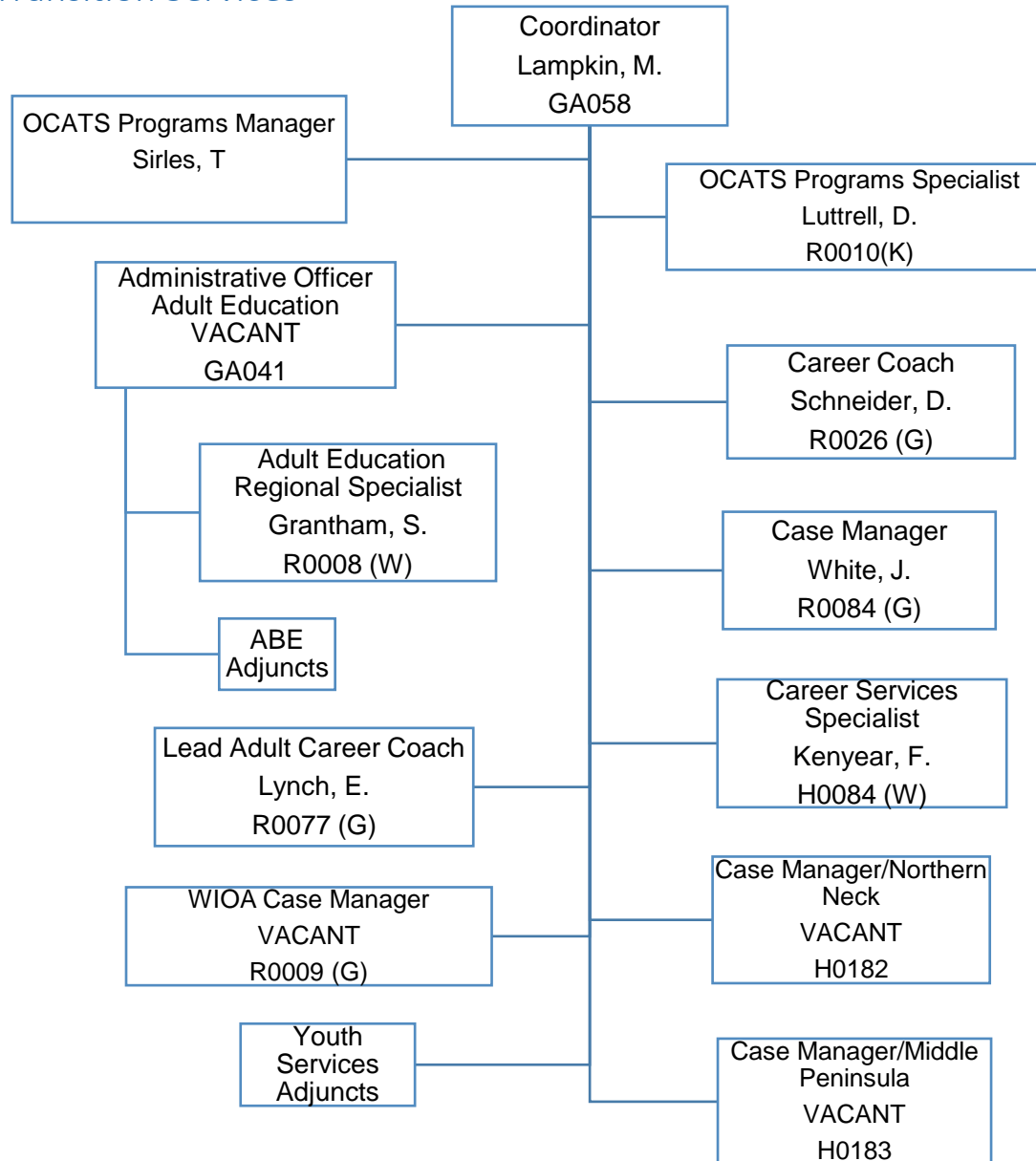

VP of Finance & Administrative Services

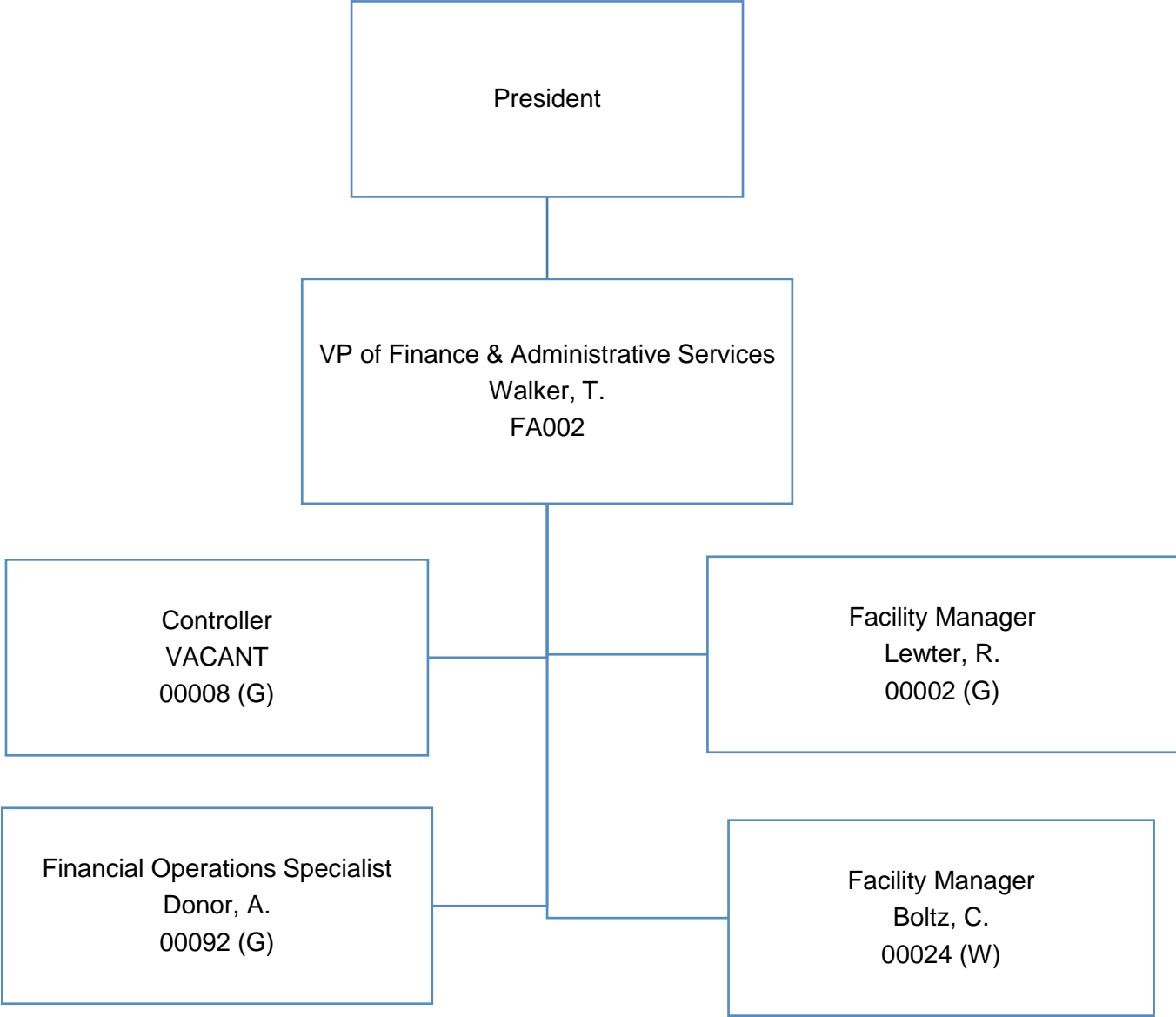

VP of Finance & Administrative Services; Business Office

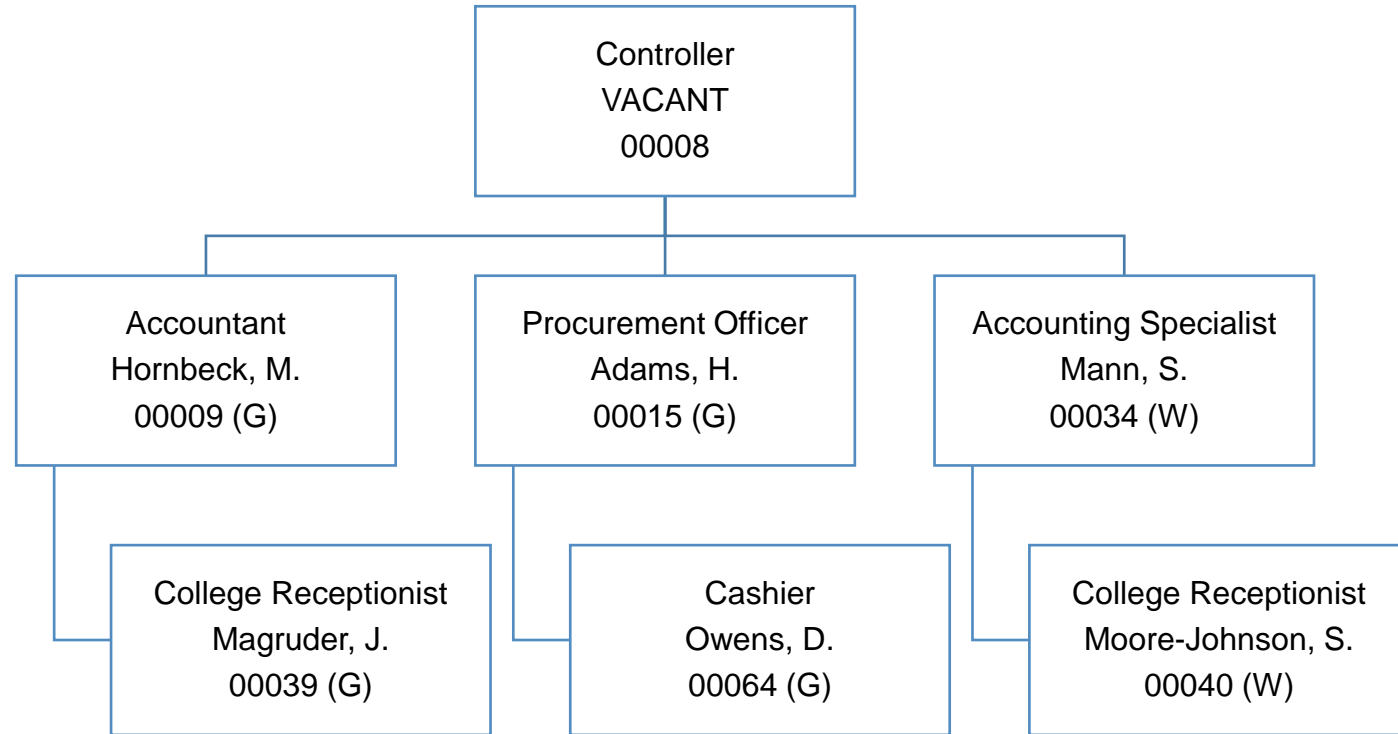

VP of Finance & Administrative Services; Facilities

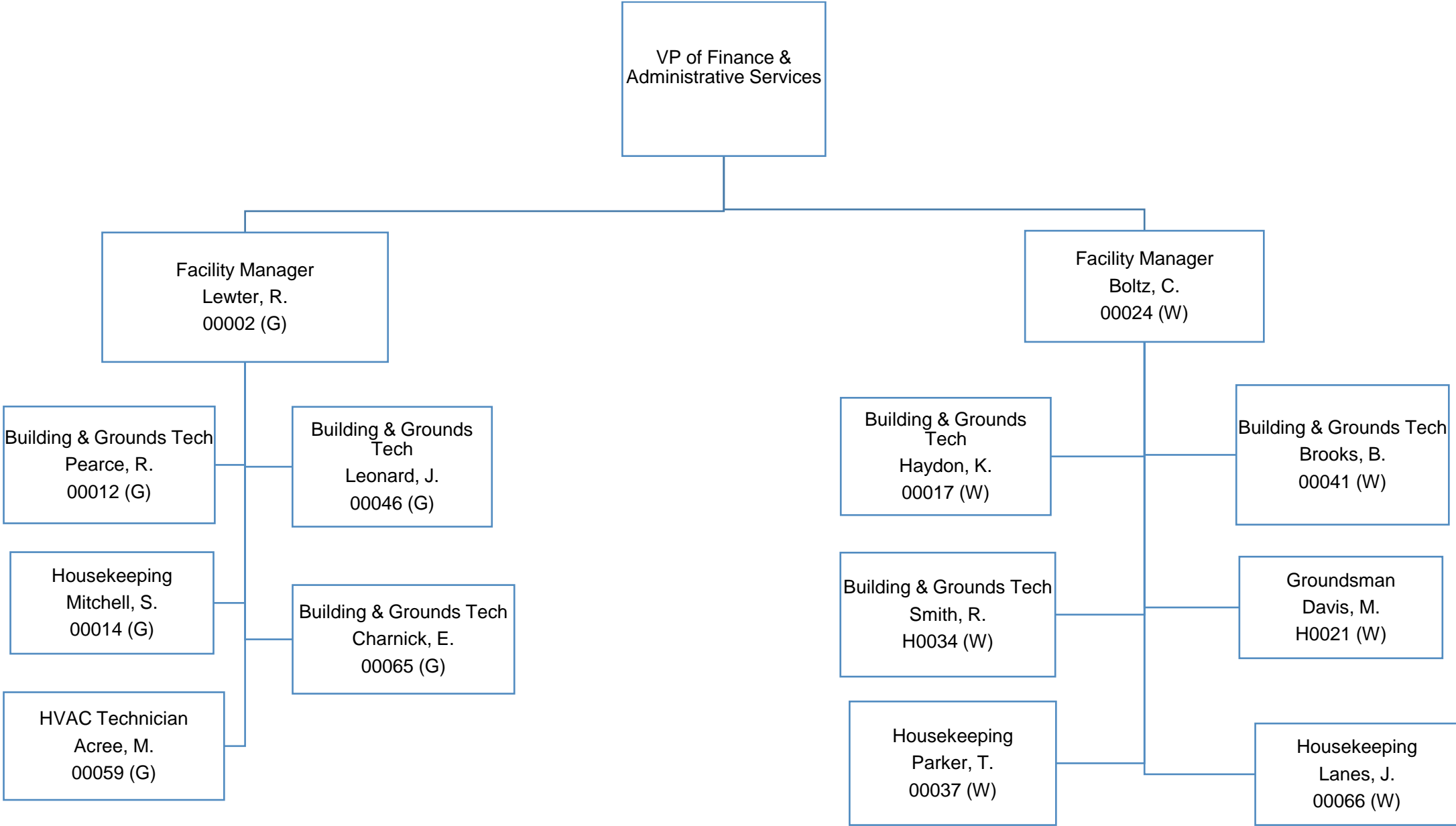

VP College Advancement & Marketing

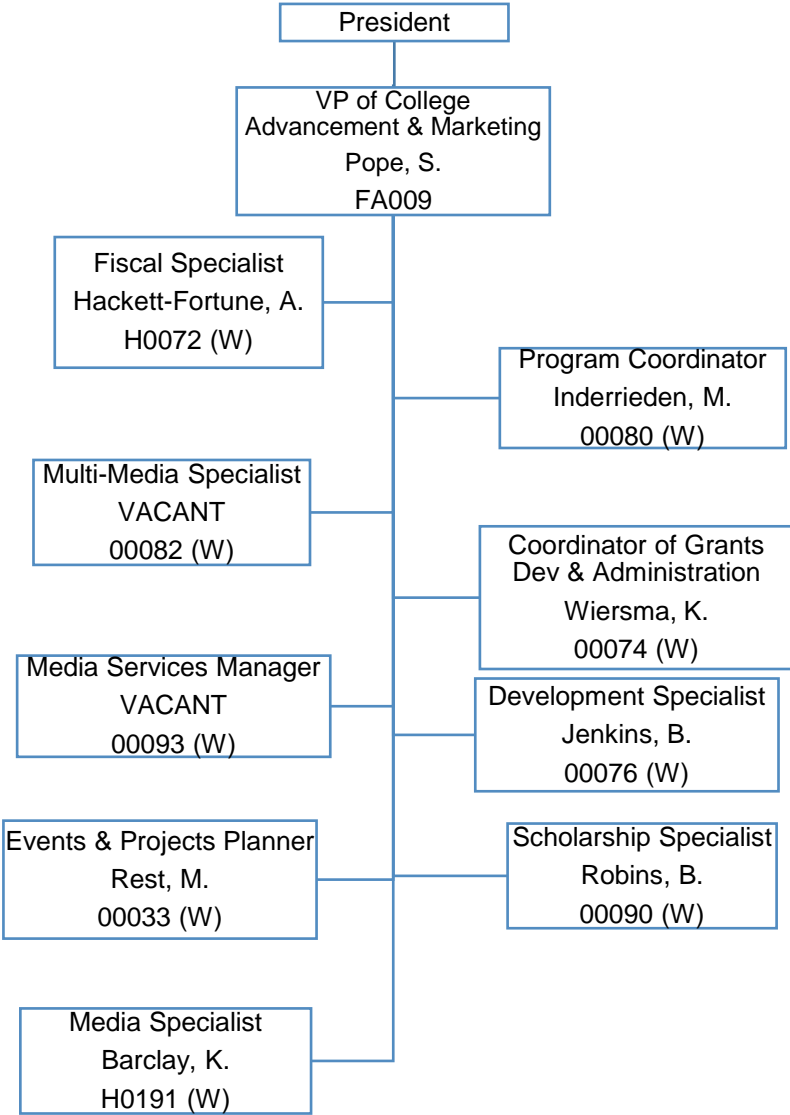

Office of the President; Human Resources

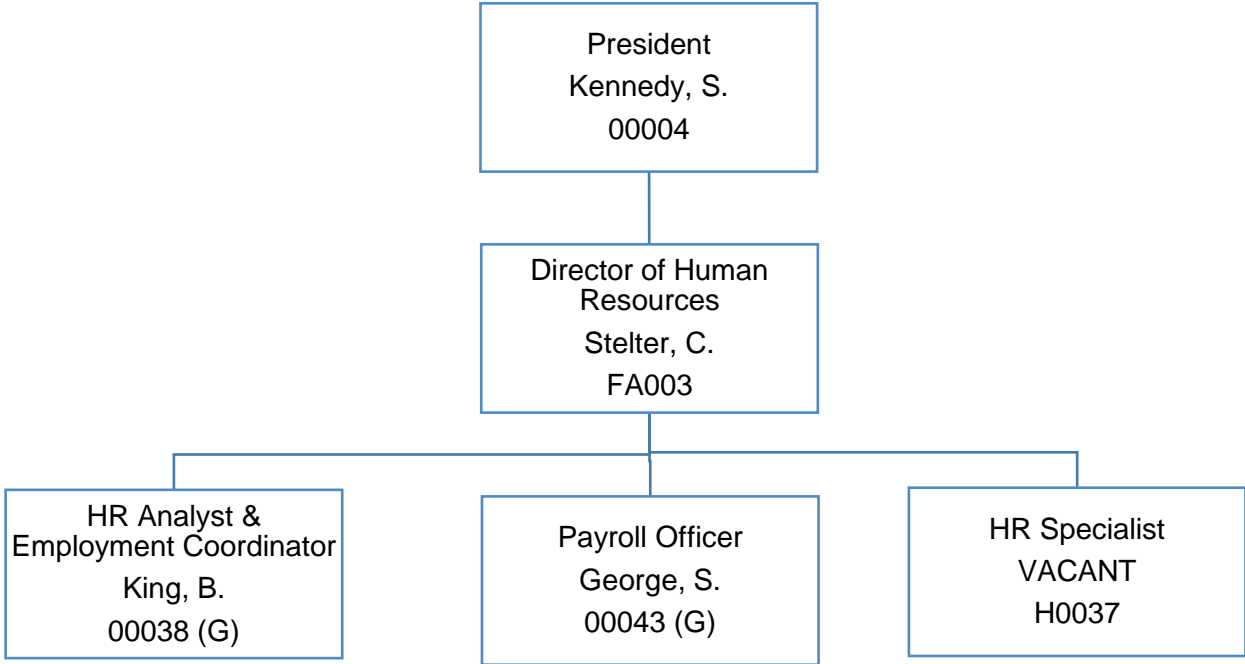

Office of the President; Technology

