

Organization Chart

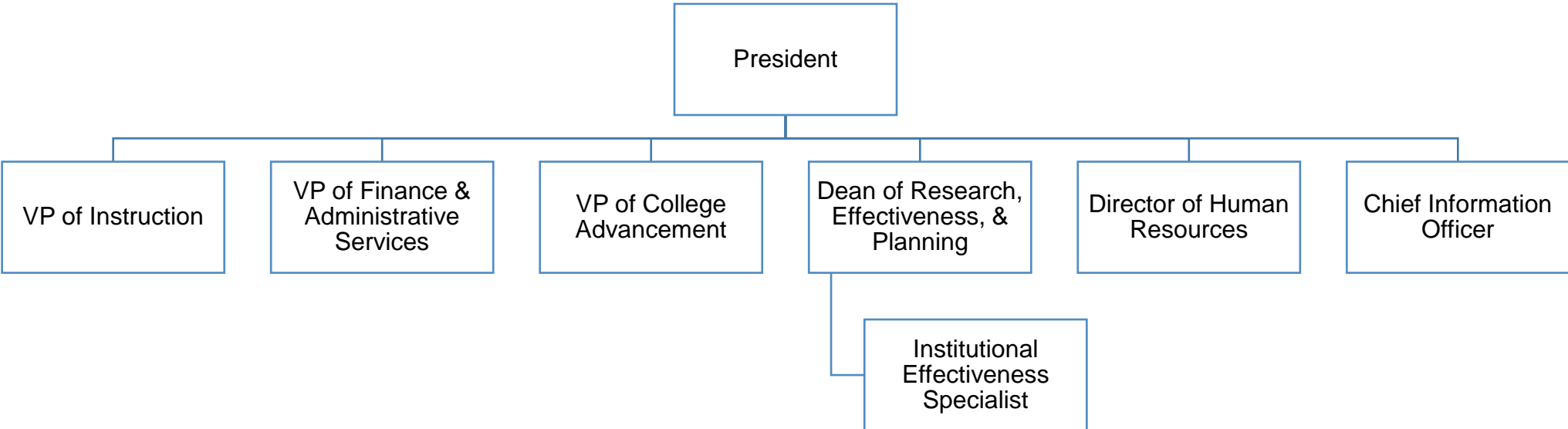

LEGEND:

- (G) = Glens Campus
- (W) = Warsaw Campus
- (KG) = King George Campus
- (NK) = New Kent
- All Numeric = Classified Staff
- FA = Administrative Faculty
- F = Faculty
- W = Wage
- R = Restricted Classified Staff
- GA = Grant Funded A&P Faculty
- RF = Restricted Faculty

Position Numbers in Blue = Administrative Council

* = Executive Staff

President

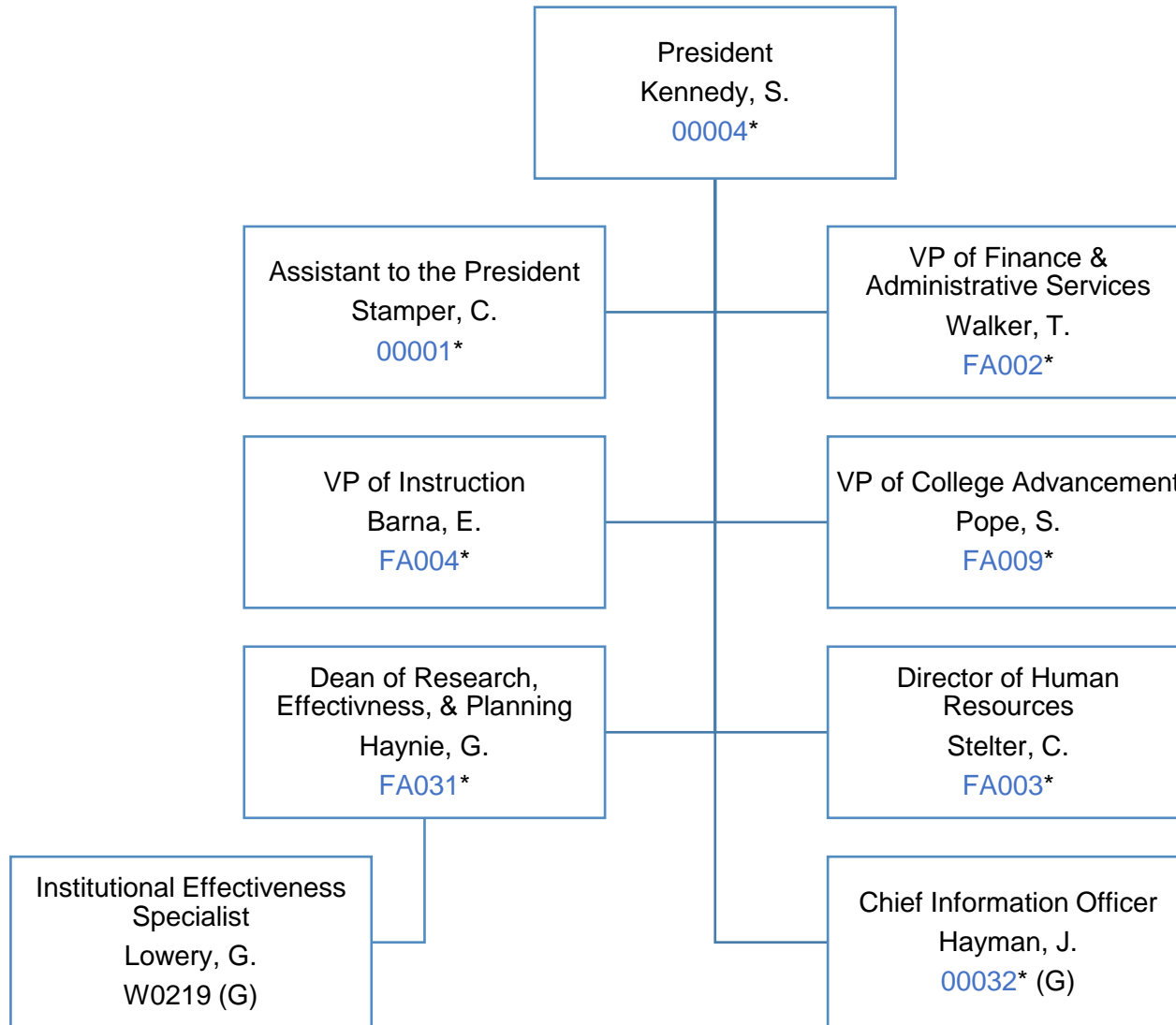

VP of Instruction

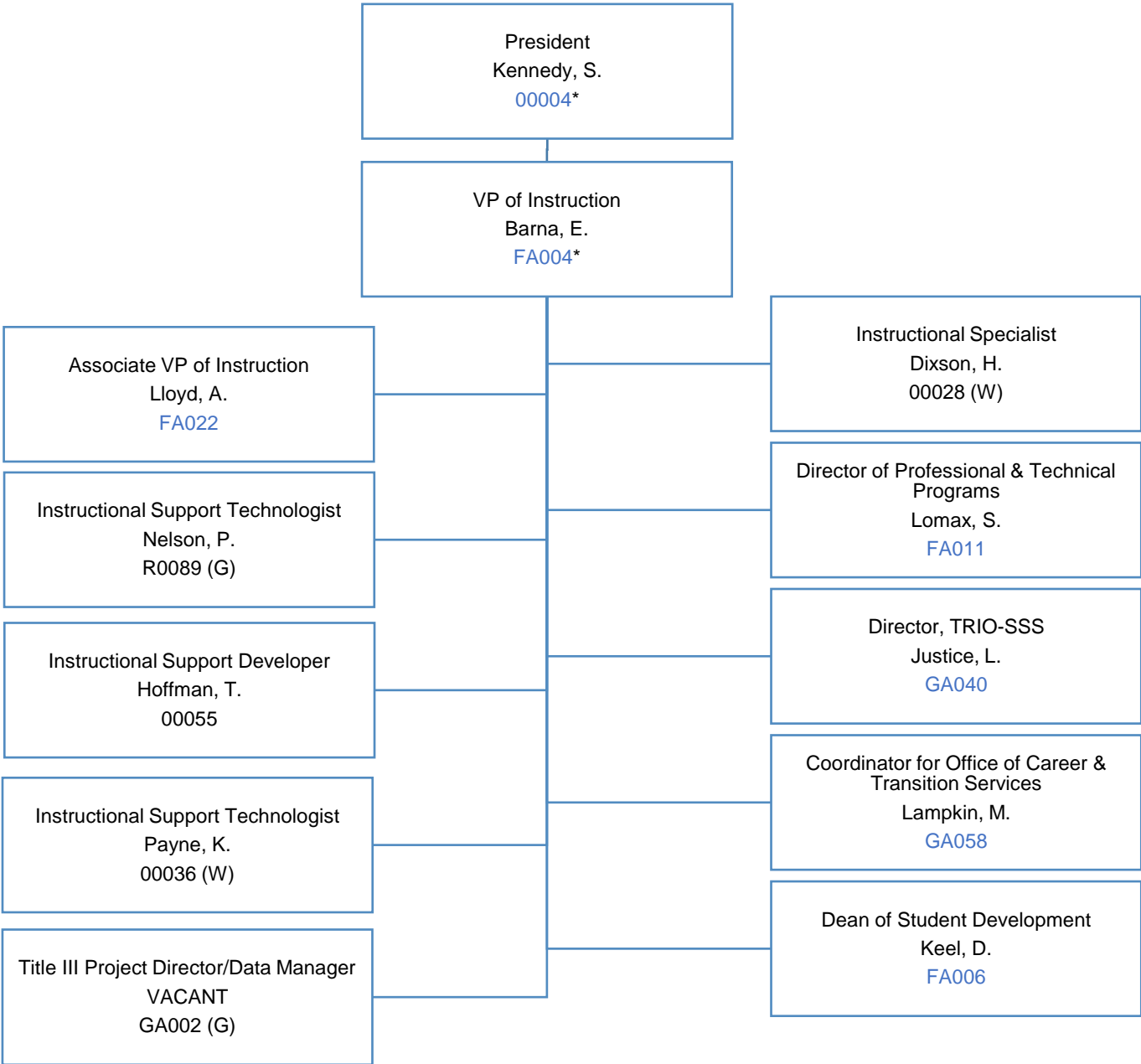

VP of Instruction; Associate VP of Instruction

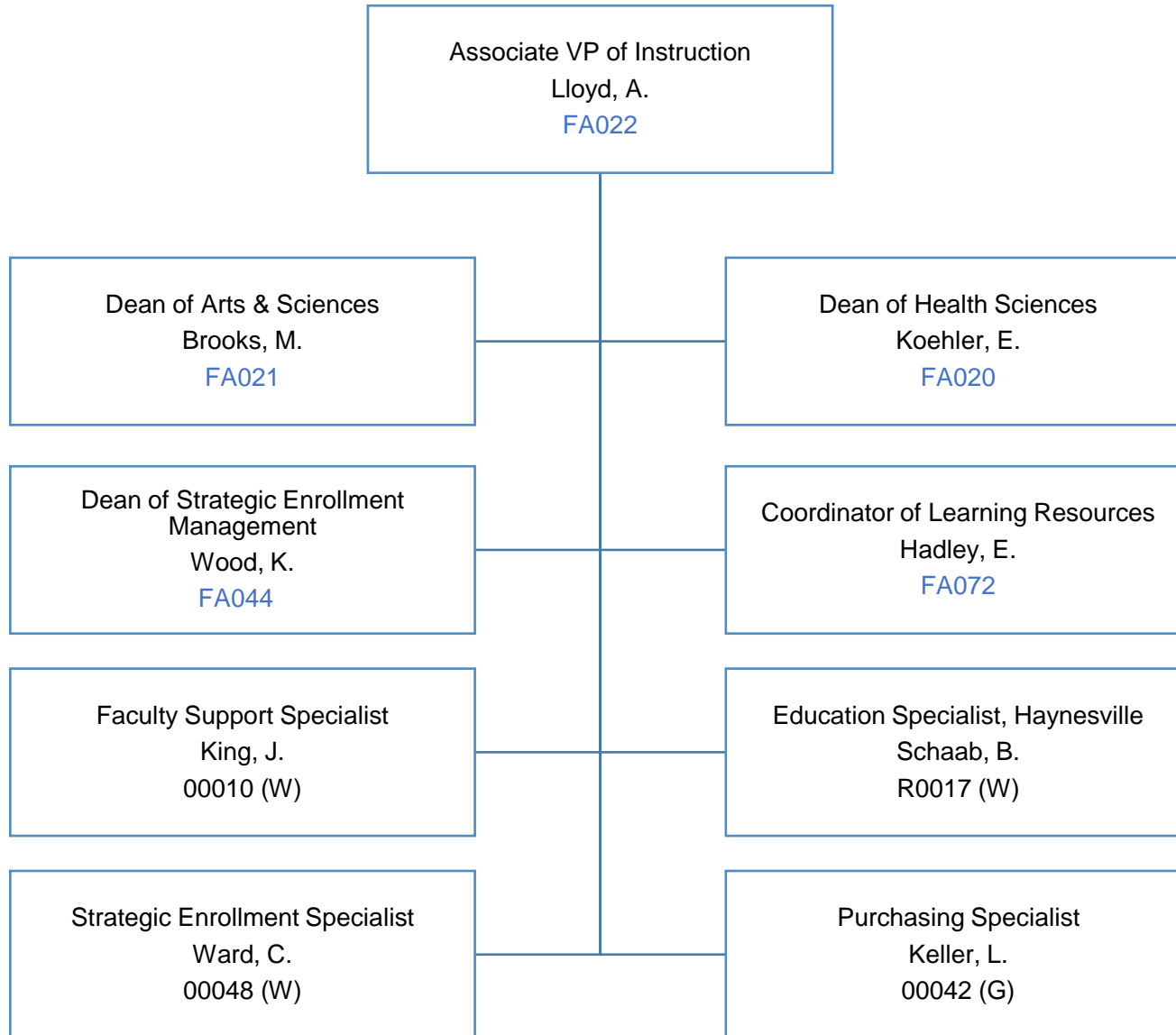

Associate VP of Instruction; Dean of Arts and Sciences

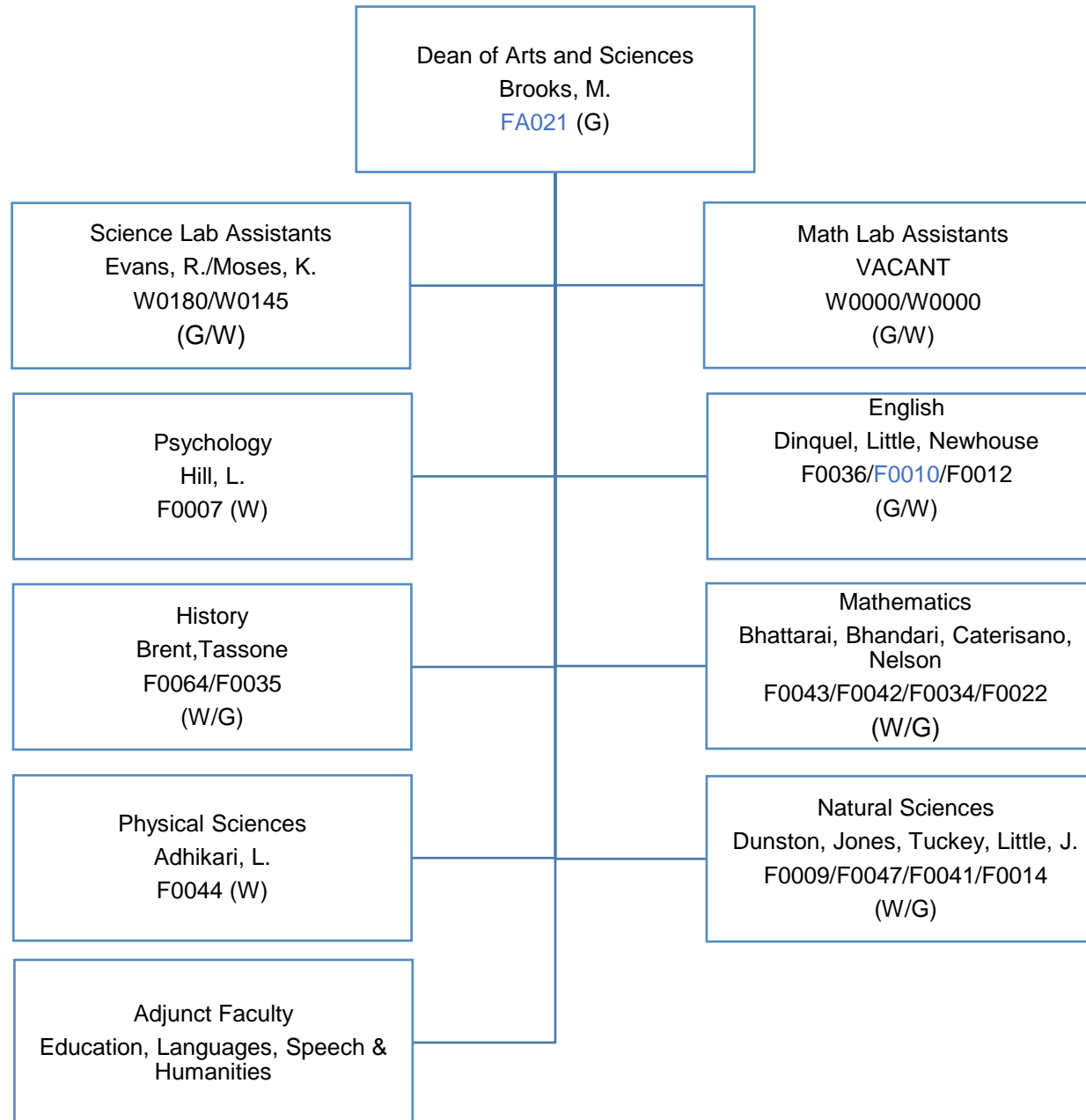

Associate VP of Instruction; Dean of Health Sciences

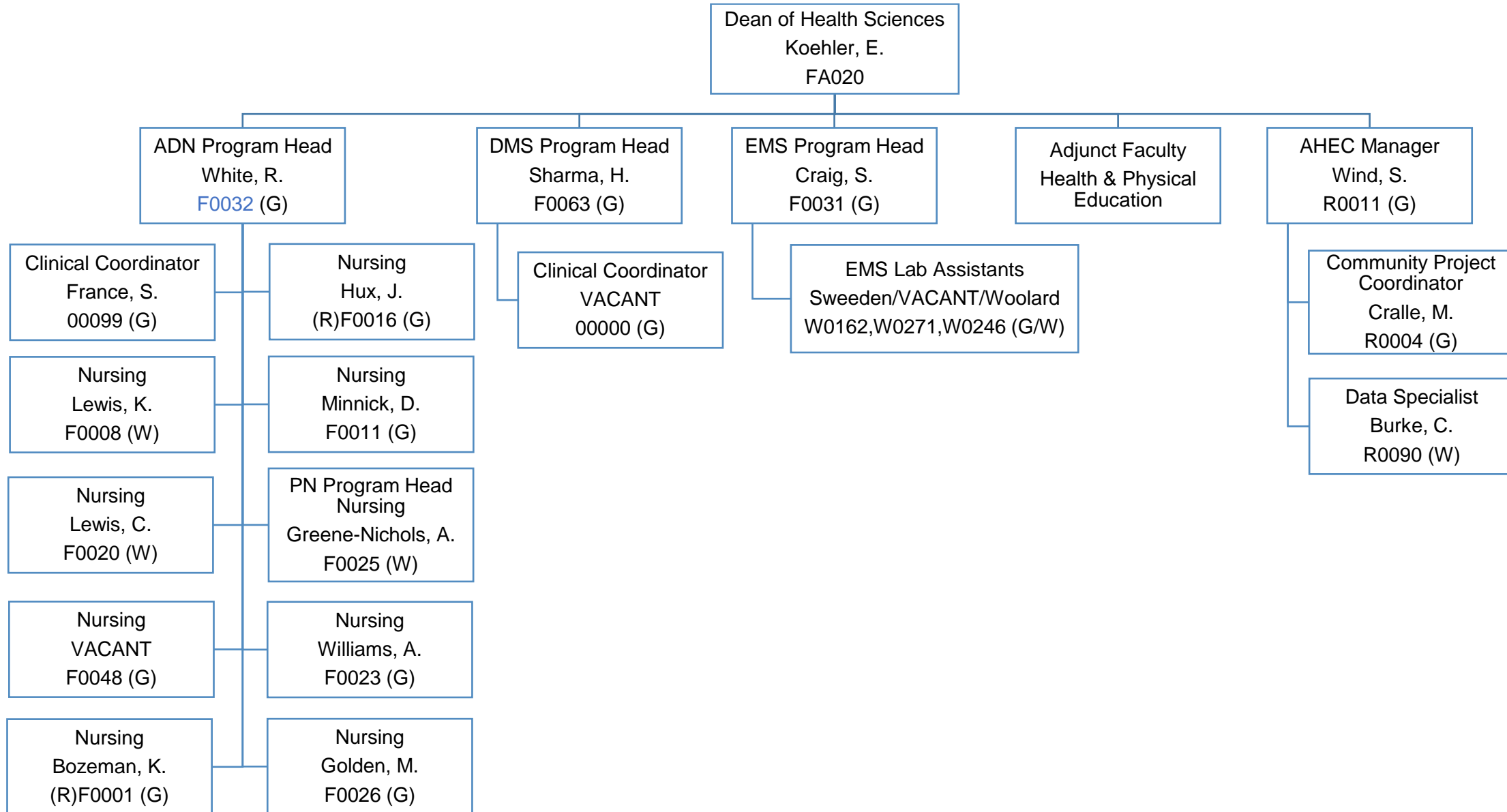

Associate VP of Instruction; Dean of Strategic Enrollment Management

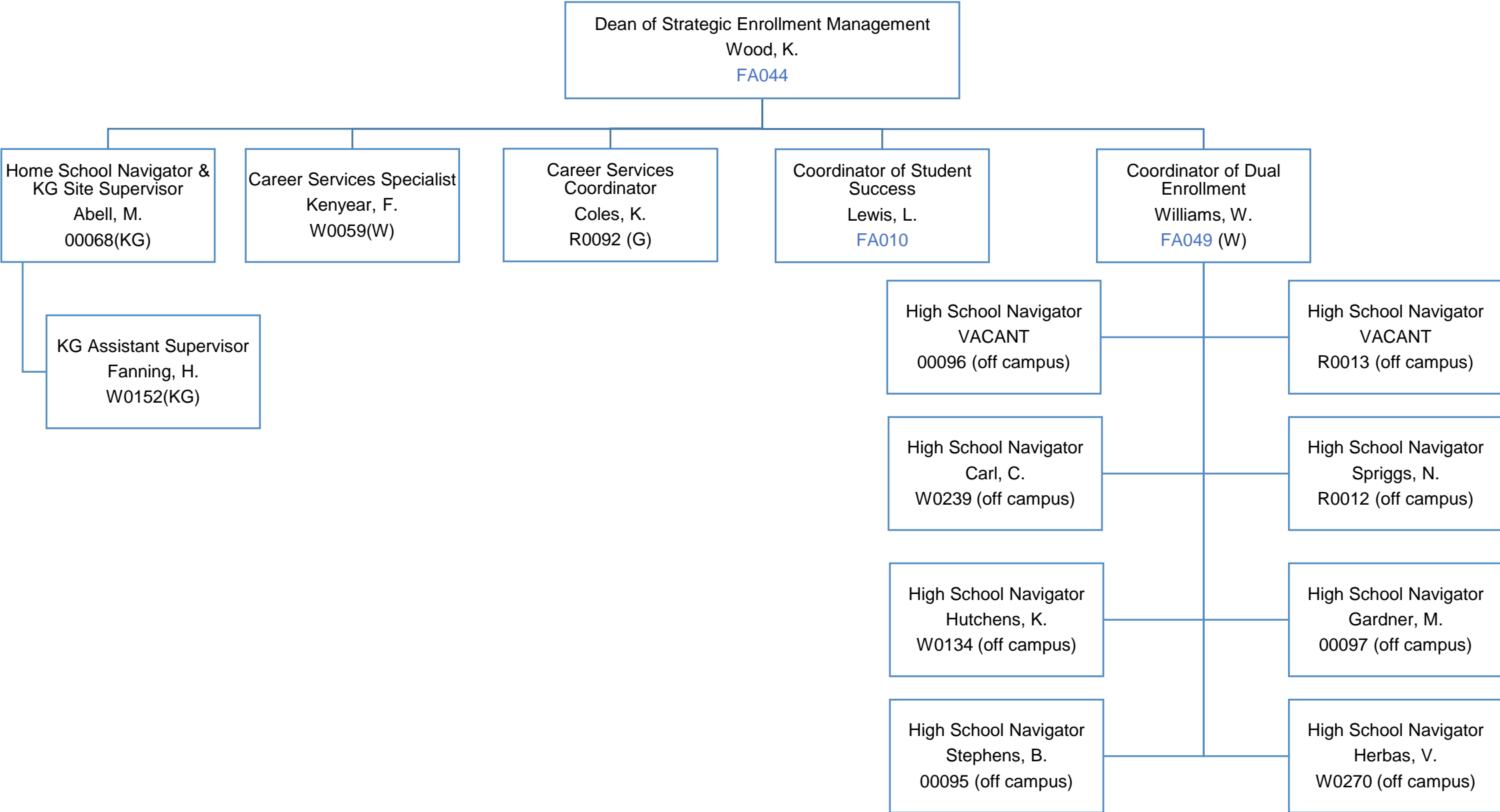

Dean of Strategic Enrollment Management; Advising Team

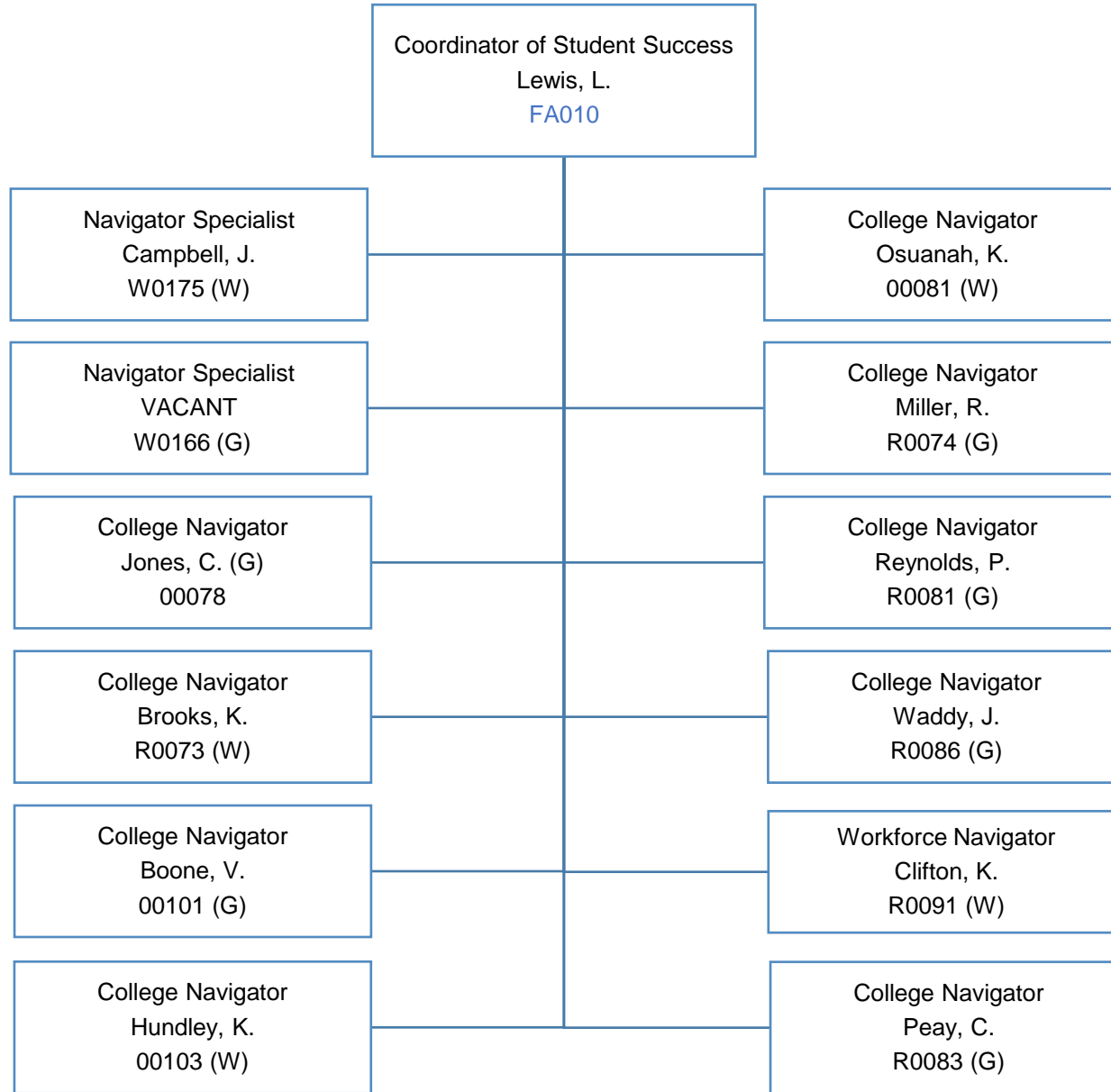

Associate VP of Instruction; Coordinator of Library Resources

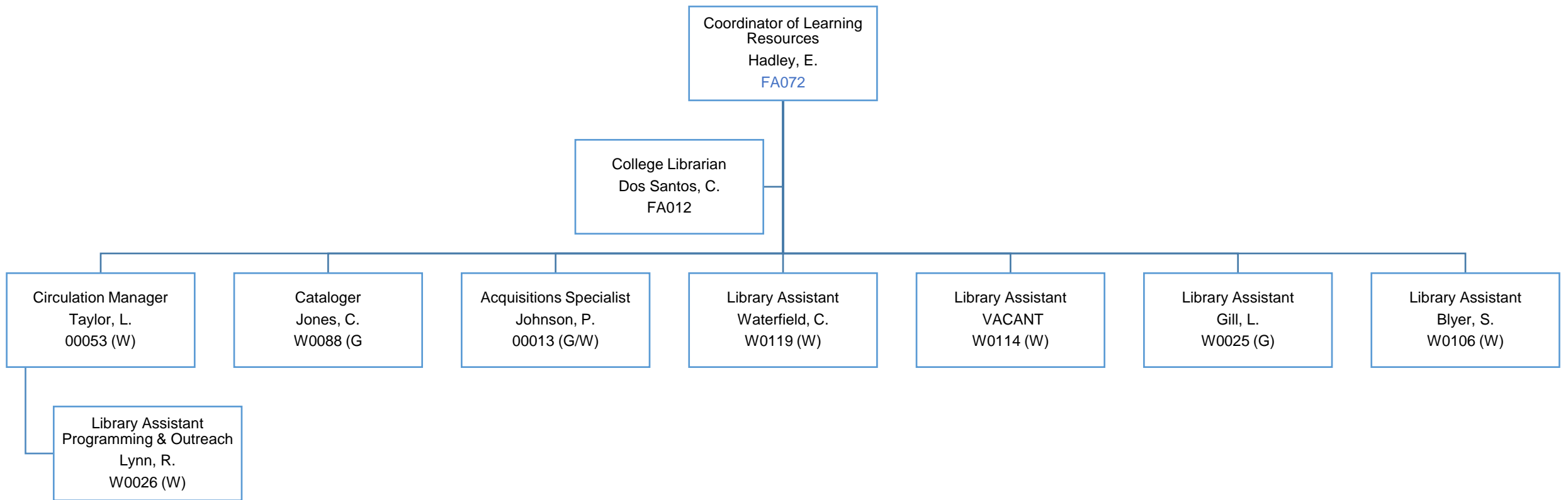

VP of Instruction; Director of Professional & Technical Programs

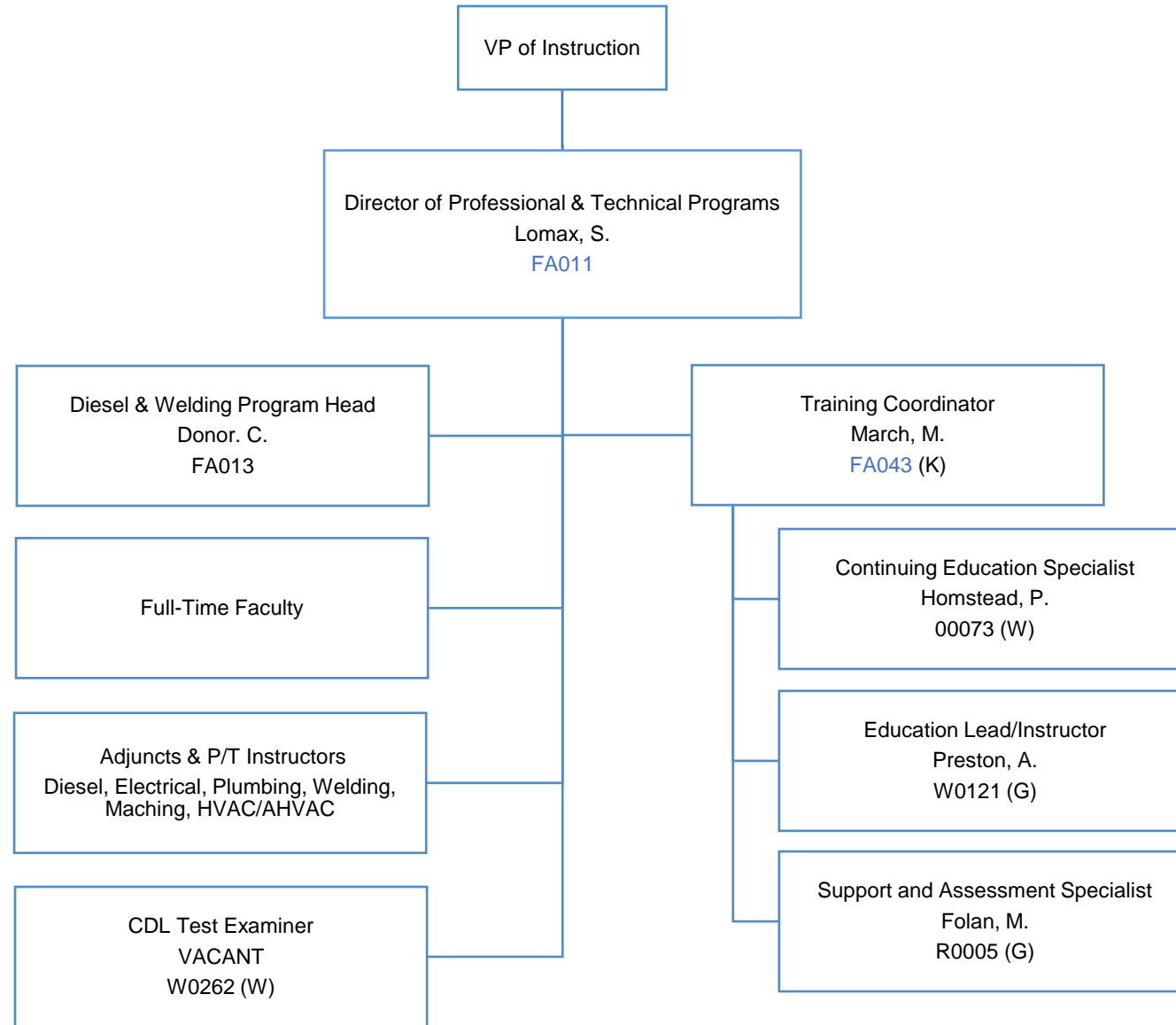

Director of Professional & Technical Programs; F/T Faculty

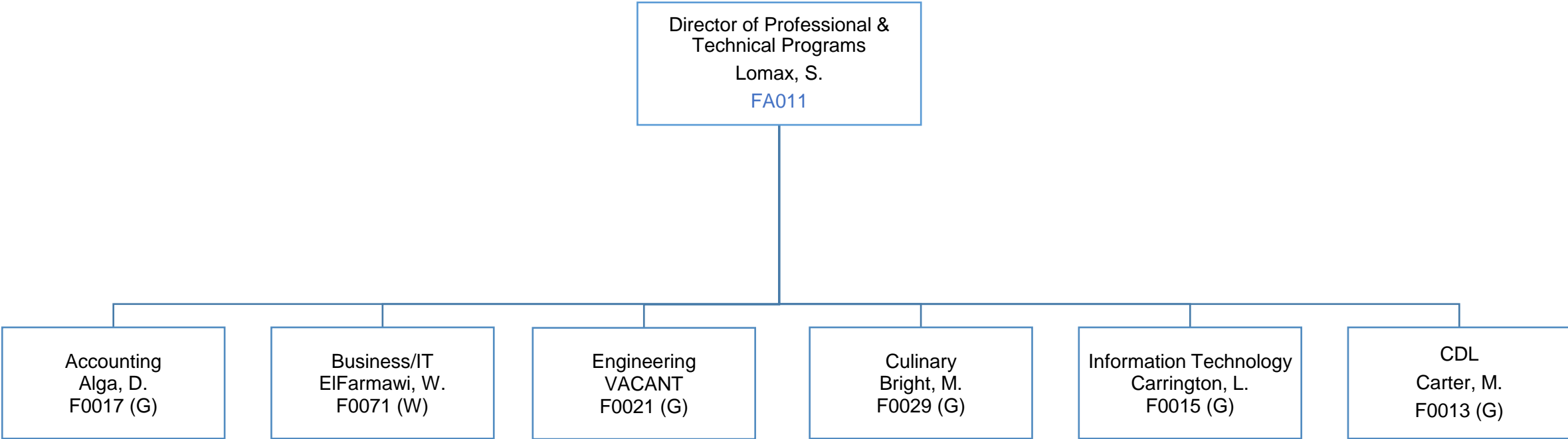

VP of Instruction; Student Support Services

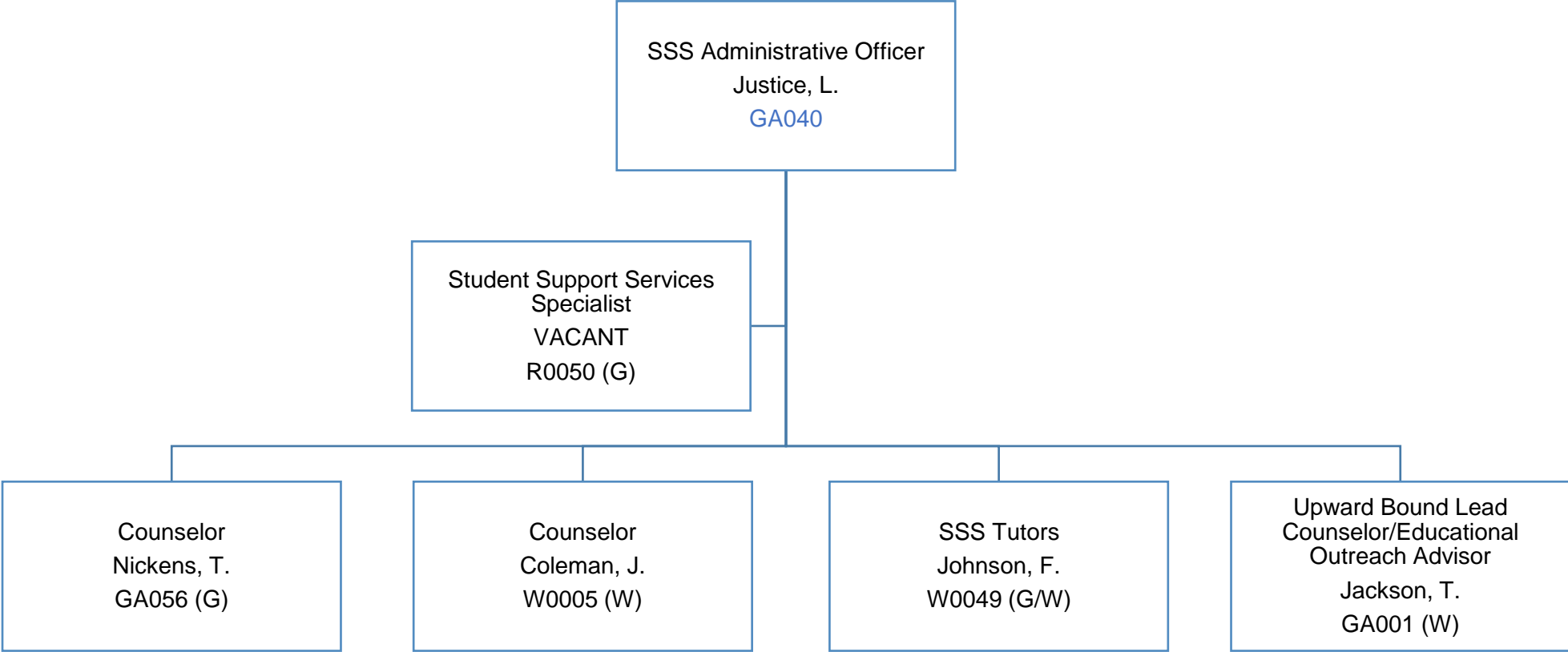

VP of Instruction; Dean of Student Development

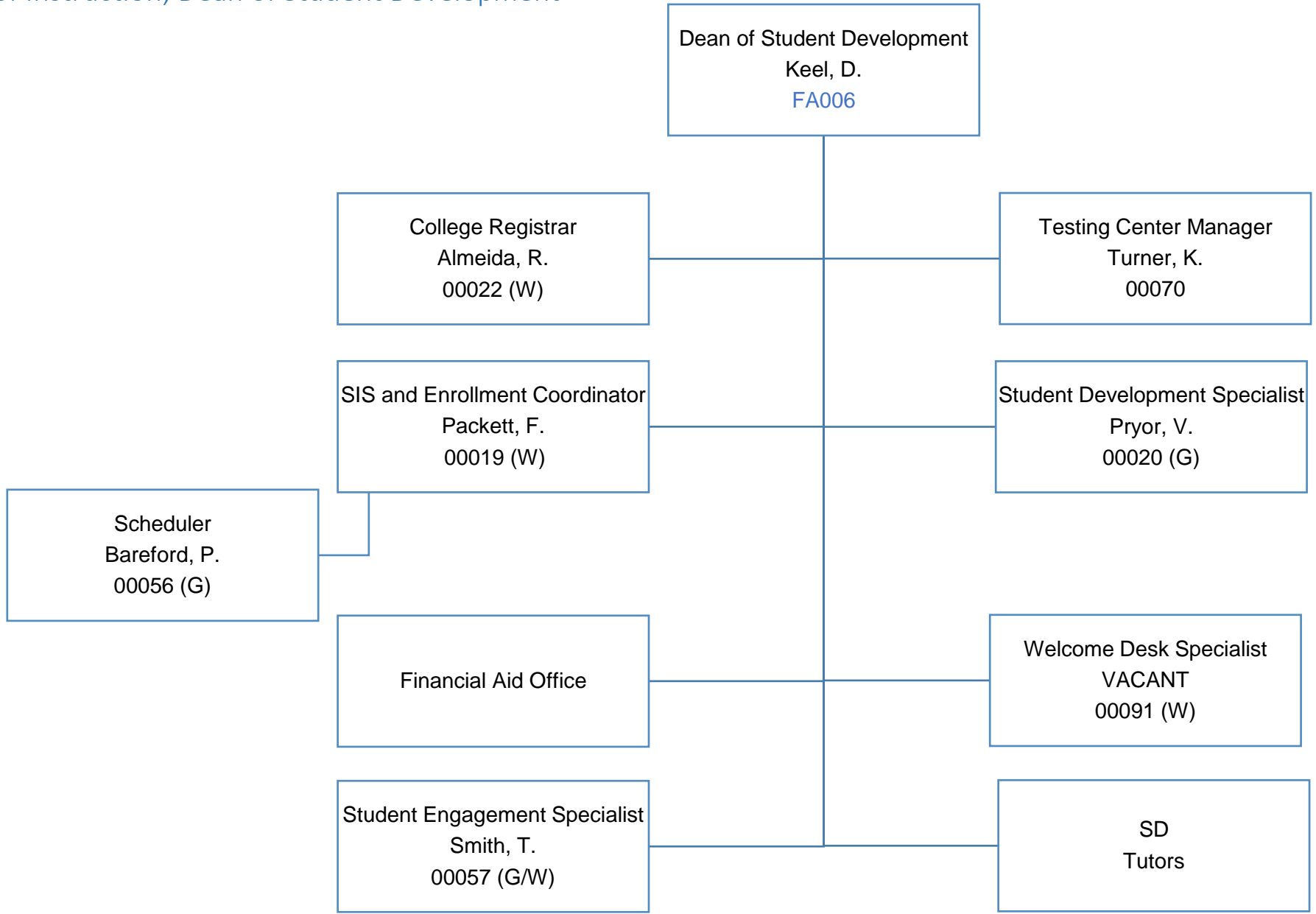

Dean of Student Development; Financial Aid

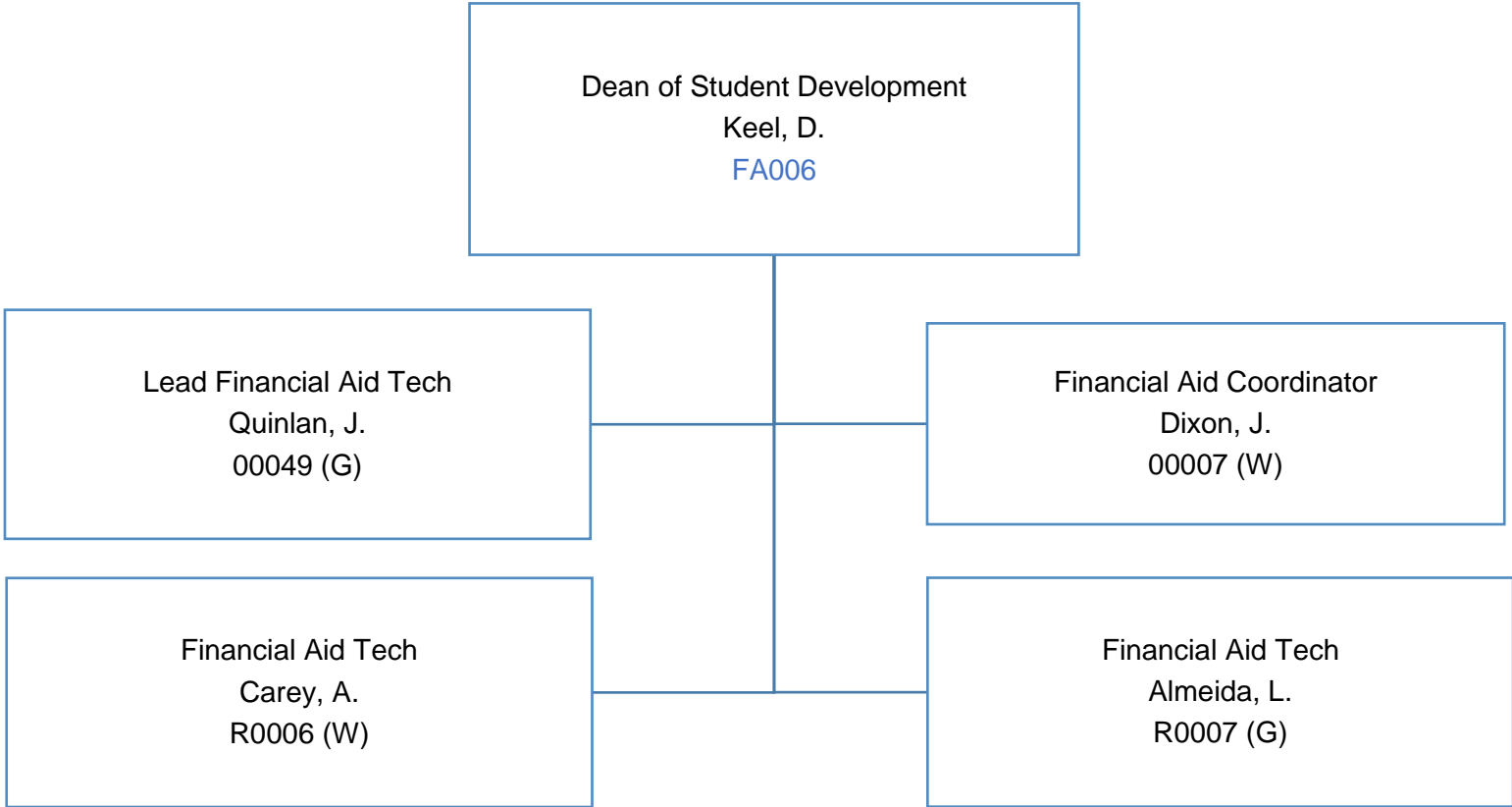

Dean of Student Development; Testing Center

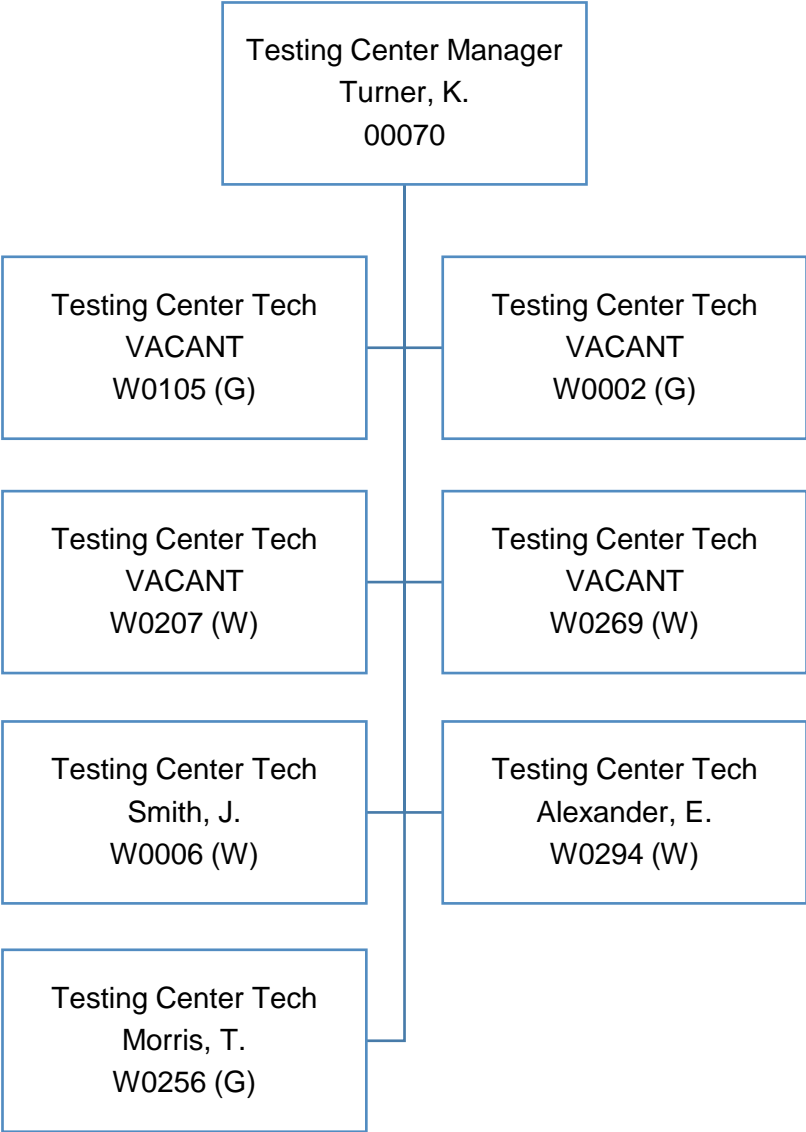

Dean of Student Development; Admissions and Records

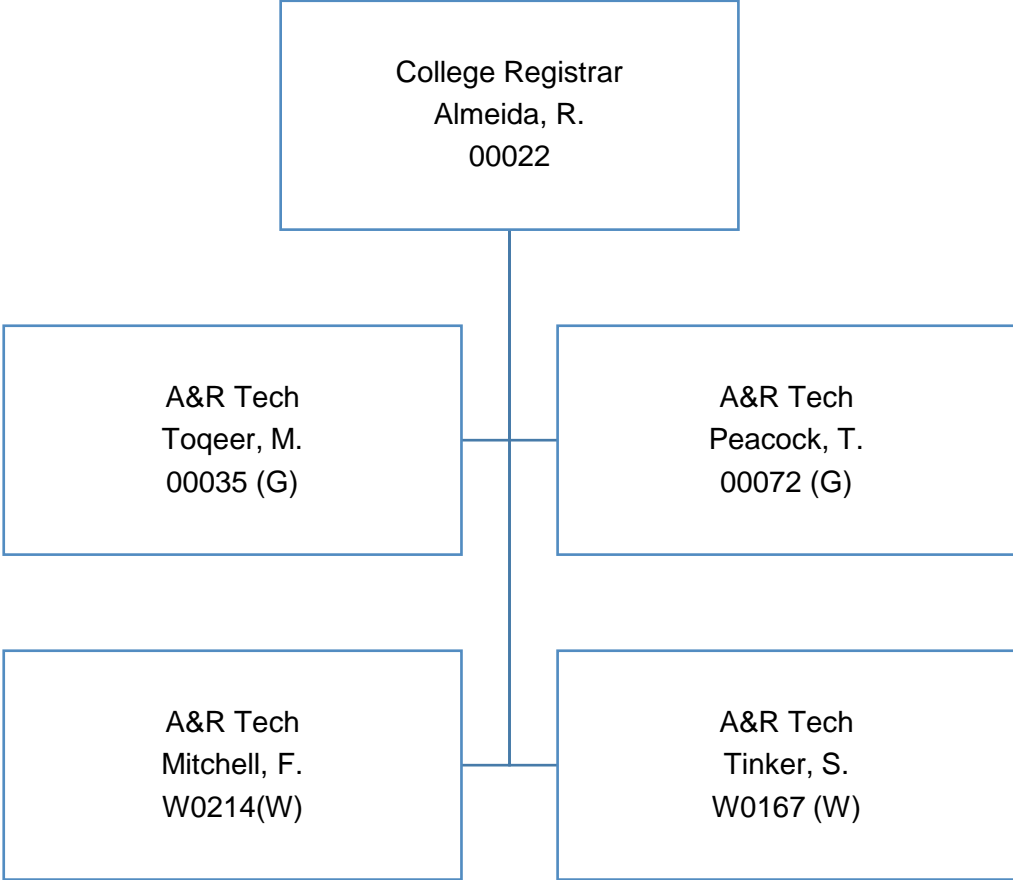

VP of Instruction; Office of Career & Transition Services

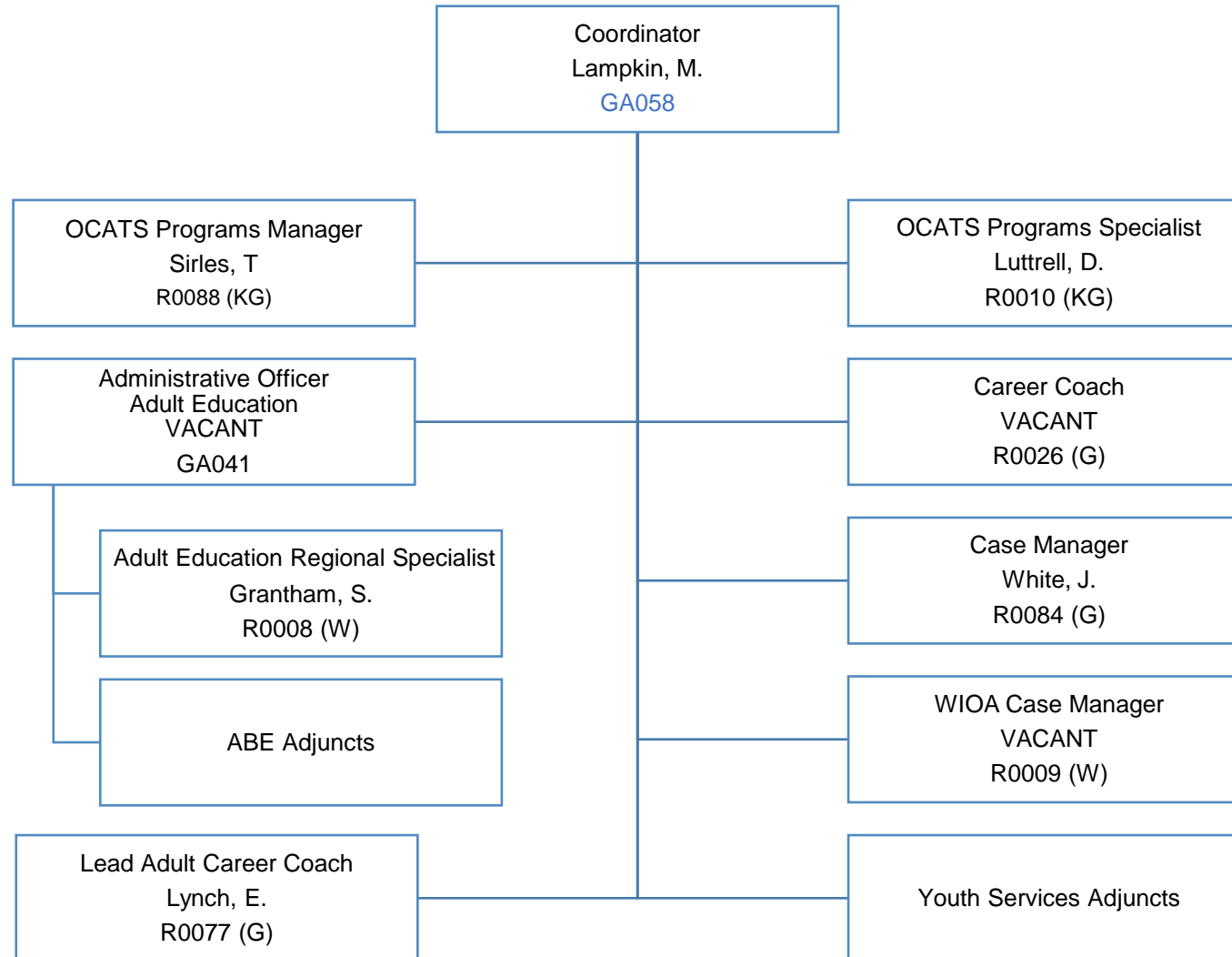

VP of Finance & Administrative Services

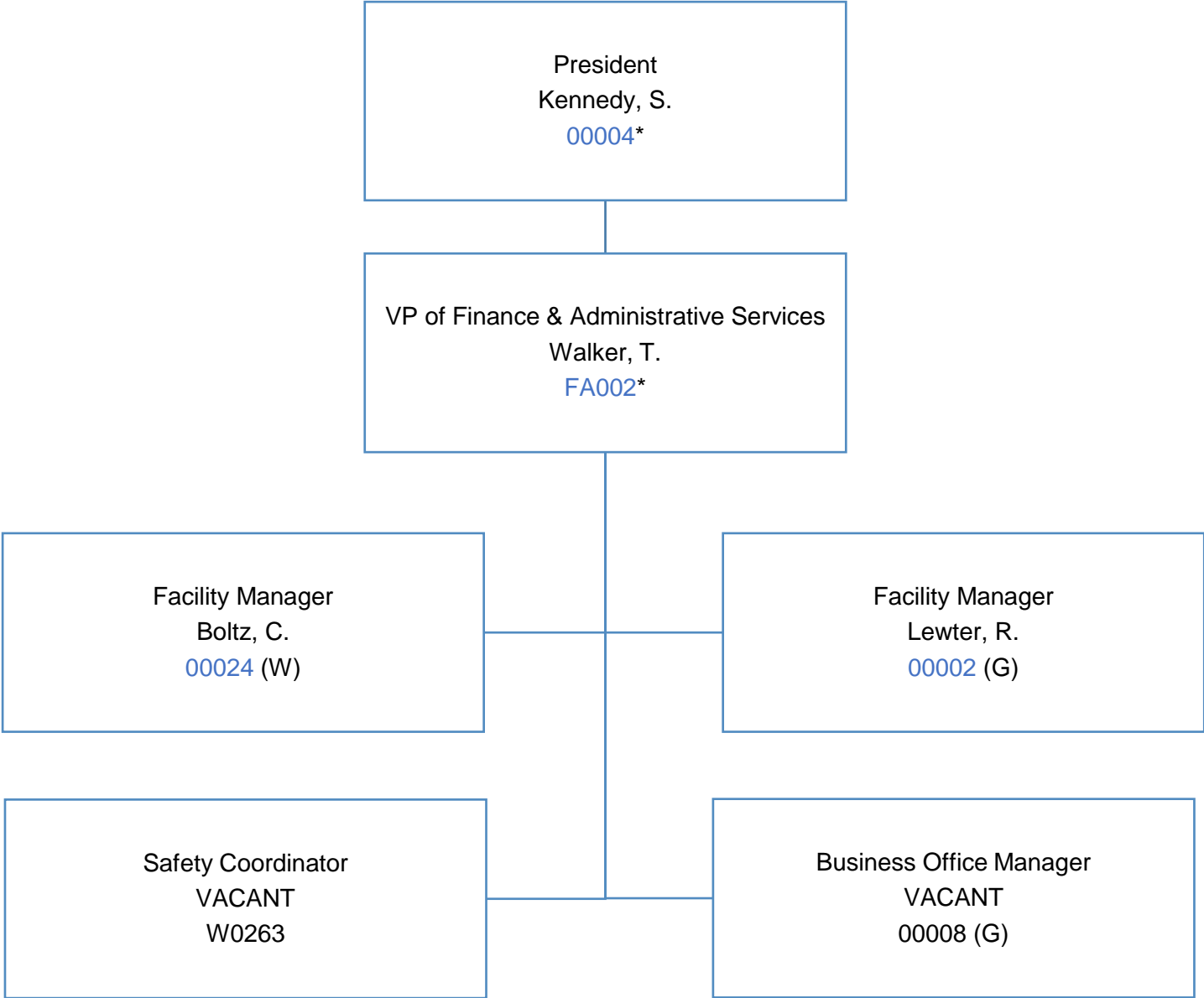

VP of Finance & Administrative Services; Business Office

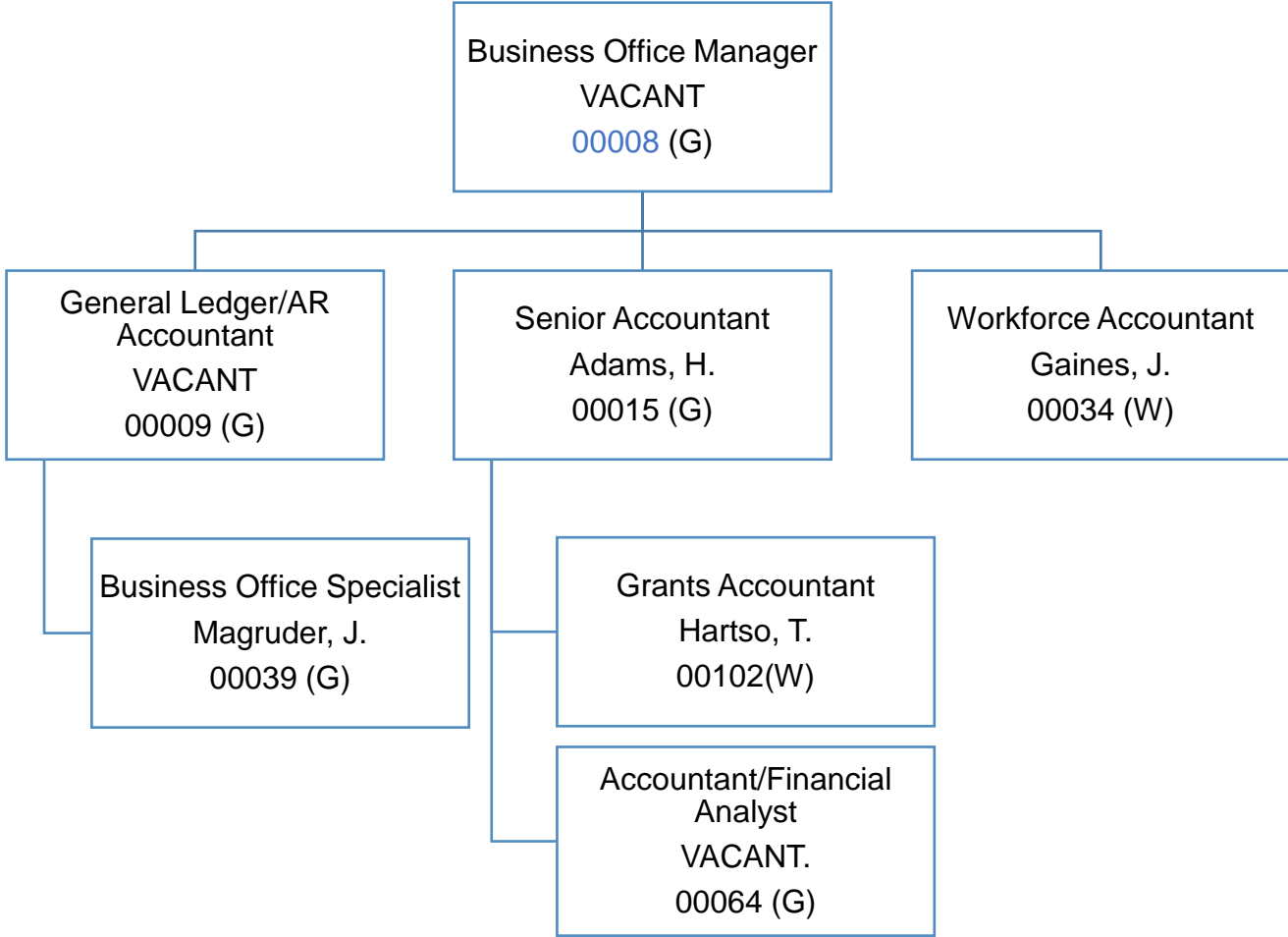

VP of Finance & Administrative Services; Facilities

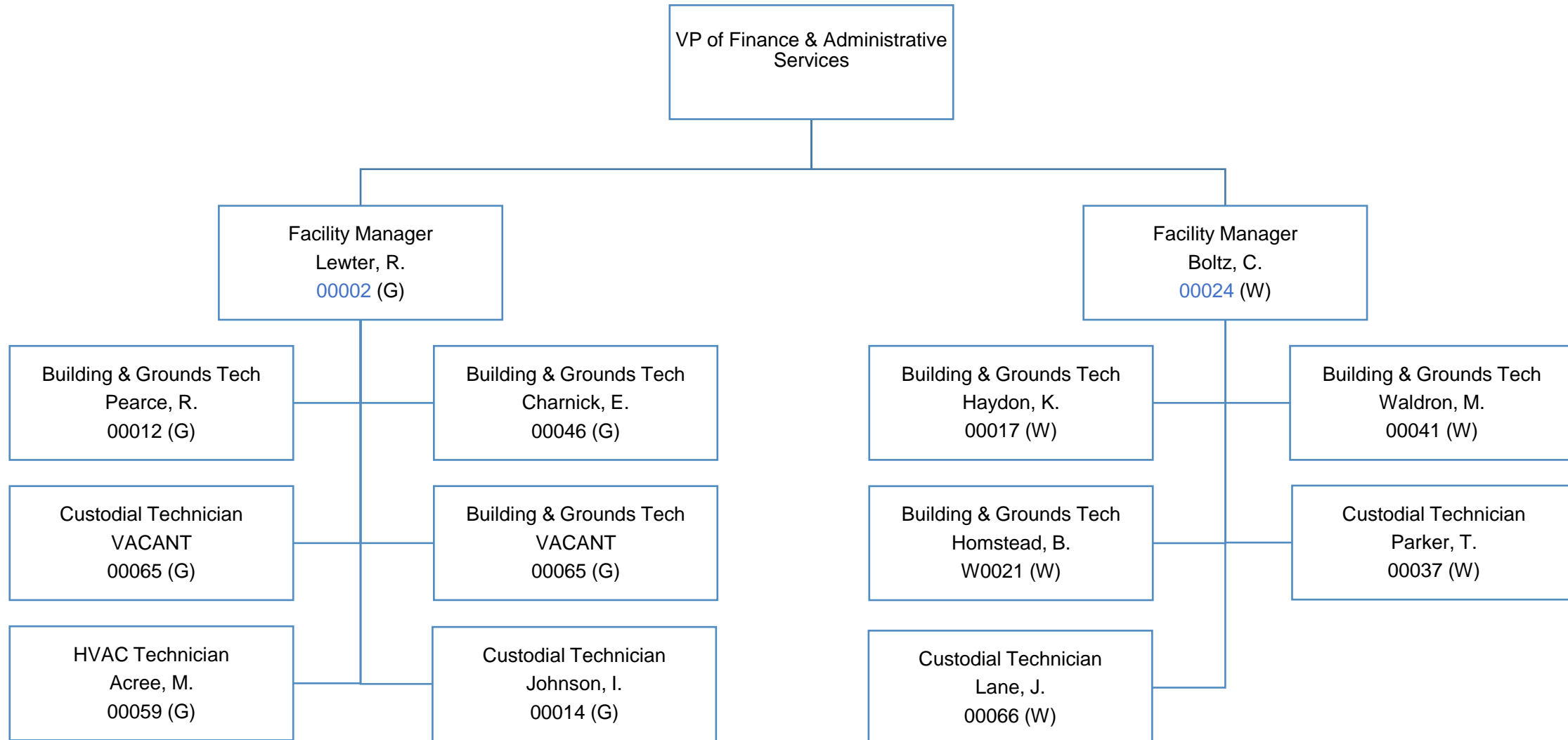

VP College Advancement

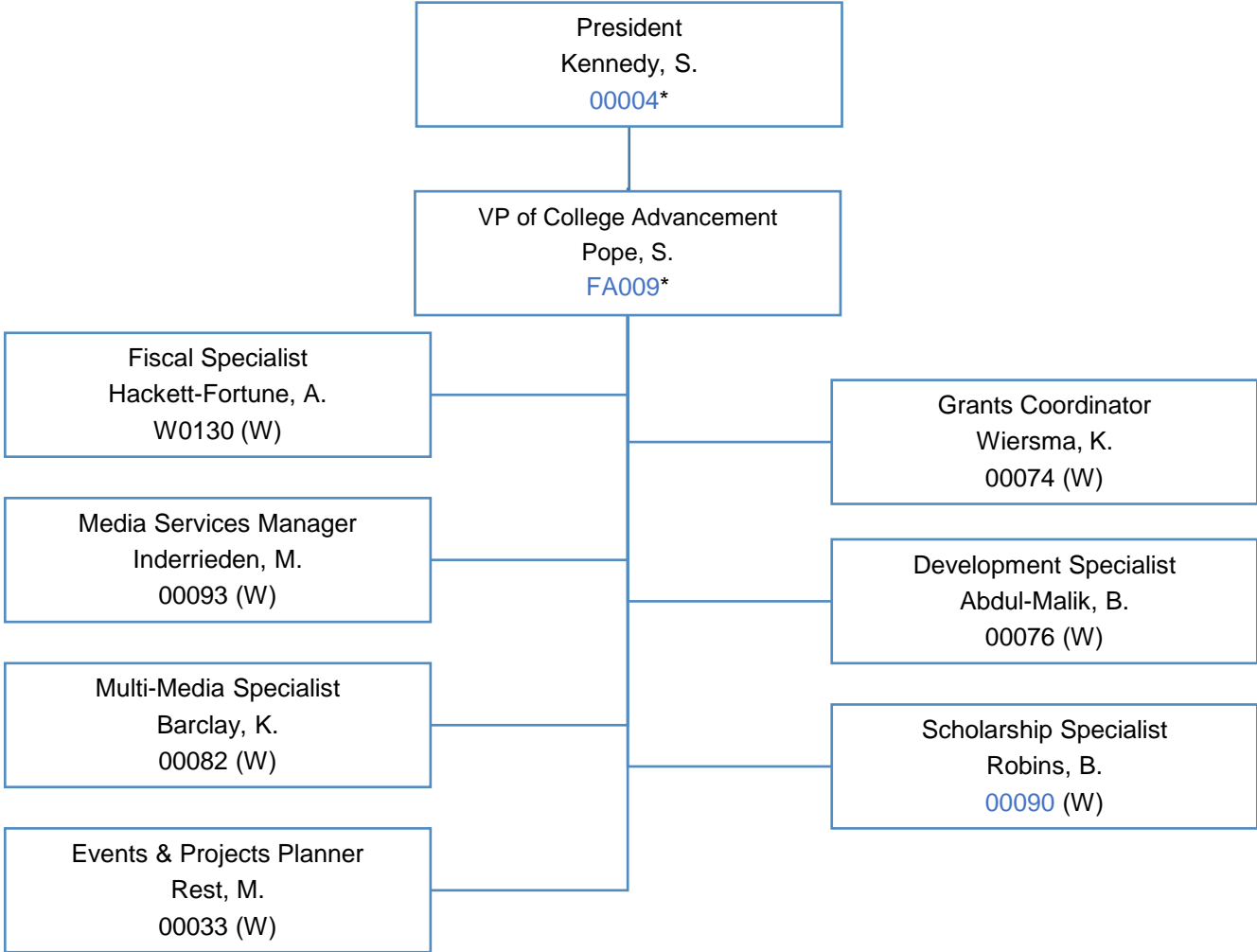

Office of the President; Human Resources

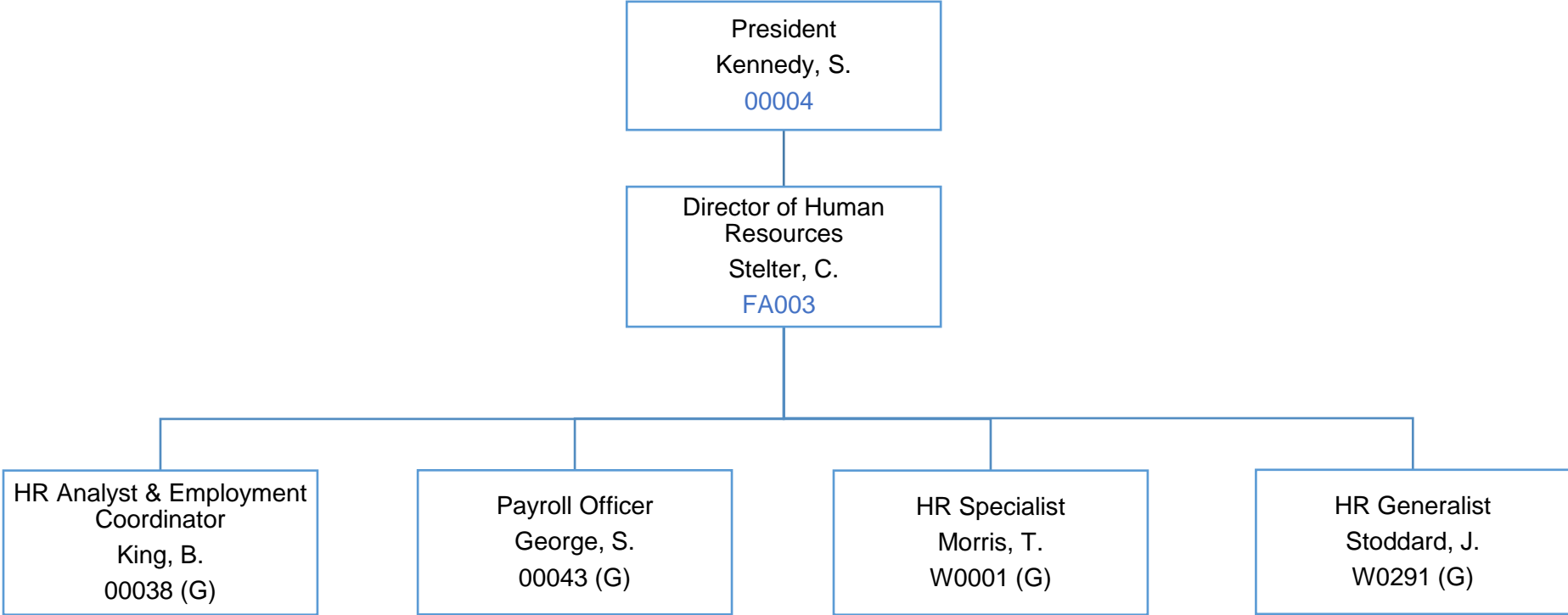

Office of the President; Technology

